

**Cellular and Molecular
Biophysics**



**UNIVERSITÀ
DI TORINO**

Department of
Life Sciences
and Systems Biology

TRANSPORTERS across plasma membrane

CFU 5 LM Biotecnologie Industriali- 6 LM Fisica - A.A. 2024/25

Corso di laurea in LM Biotecnologie Industriali- LM Fisica

The lipidic component of plasma membrane is **semipermeable**: allows the fluxes of different molecules according to their lipids solubility and dimension

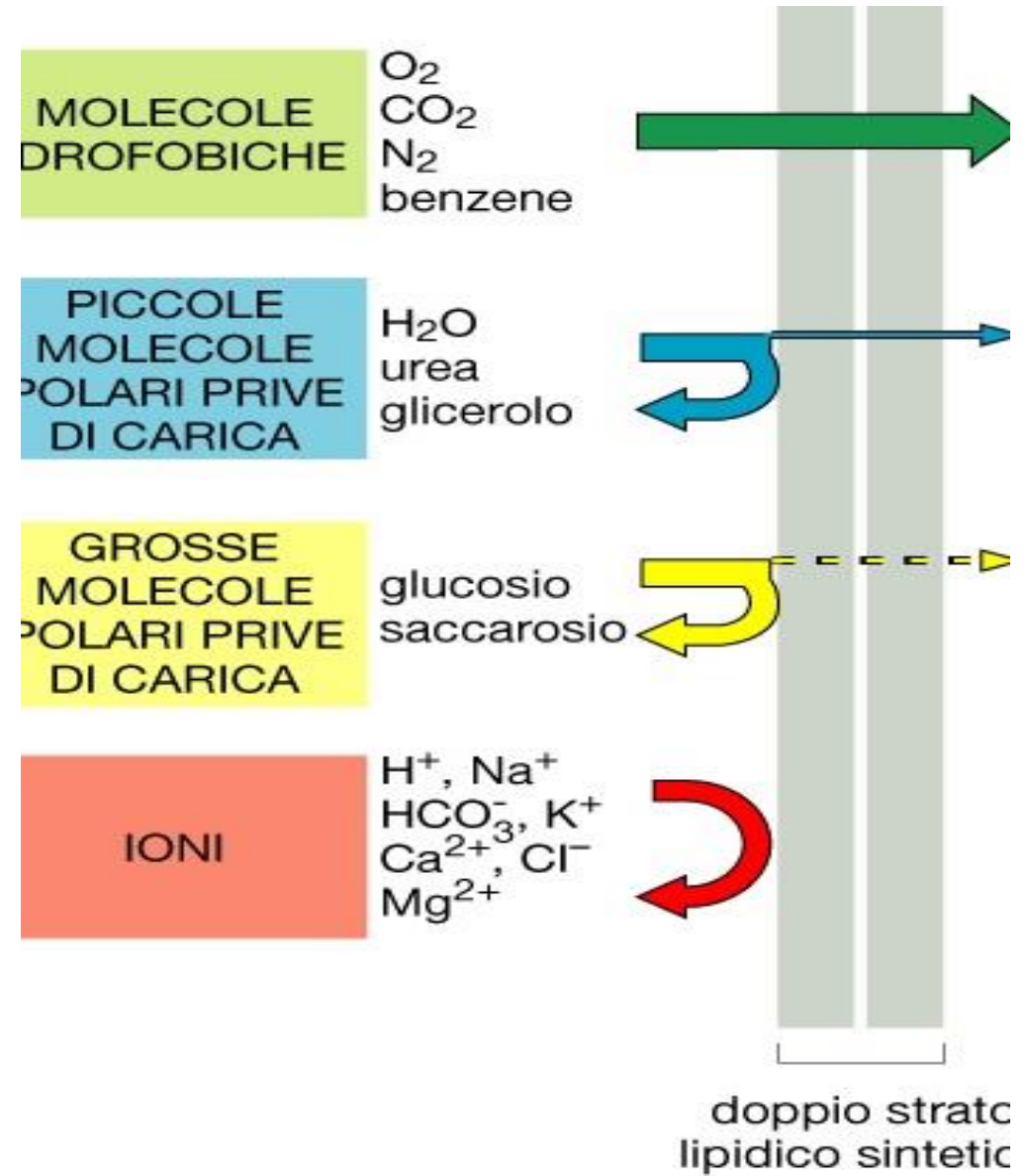

Transmembrane fluxes

SIMPLE DIFFUSION

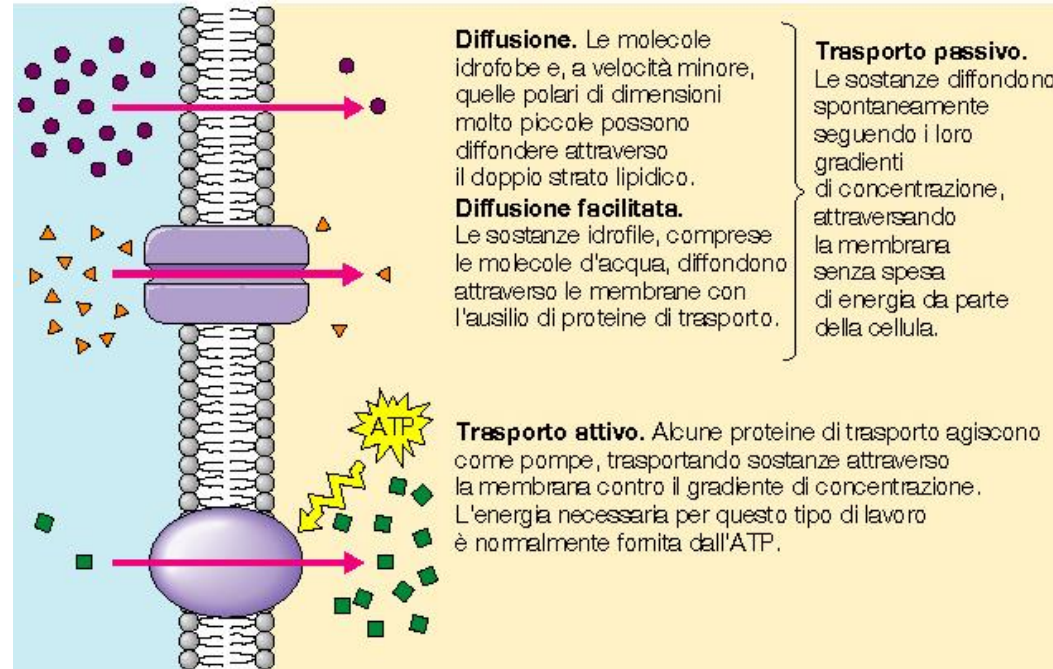

MEDIATED by carriers



✓ ionc channels

✓ carriers (transporters)

✓ pumps

Different transporters



UNIVERSITÀ
DI TORINO

Department of
Life Sciences
and Systems Biology

- Proteins that allows fluxes of molecules that can't cross the lipid bilayer by themselves
- Allow nutrients inflow, osmolality control, detossification
- Fluxes depends form the different forces that act on the molecules transported

Rate of transport is linear and not saturable in Simple diffusion

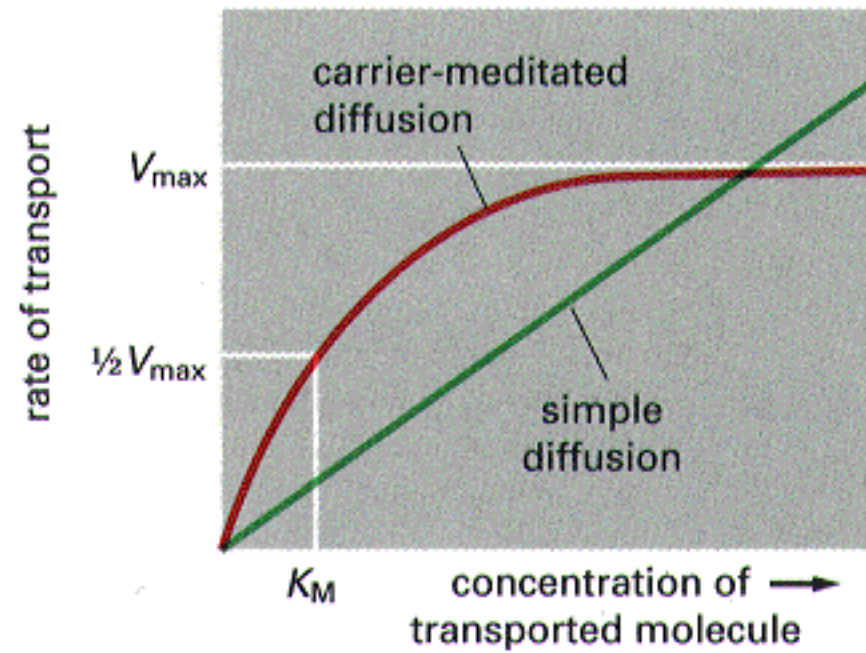

MEDIATED TRANSPORT: CARRIERS

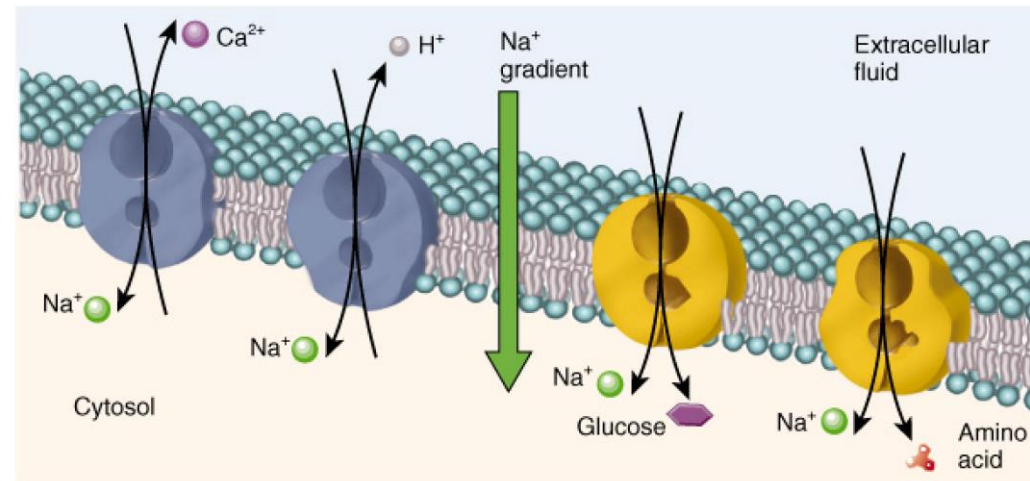
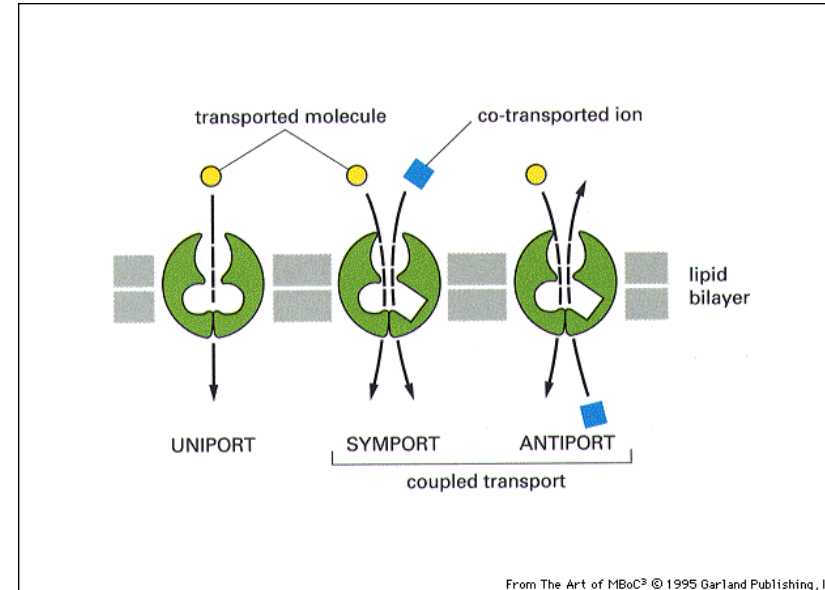

From the energetic point of view the mediated transport can be **PASSIVE** (facilitated diffusion, along chemical or electrochemical gradient) or **ACTIVE** (against gradient)

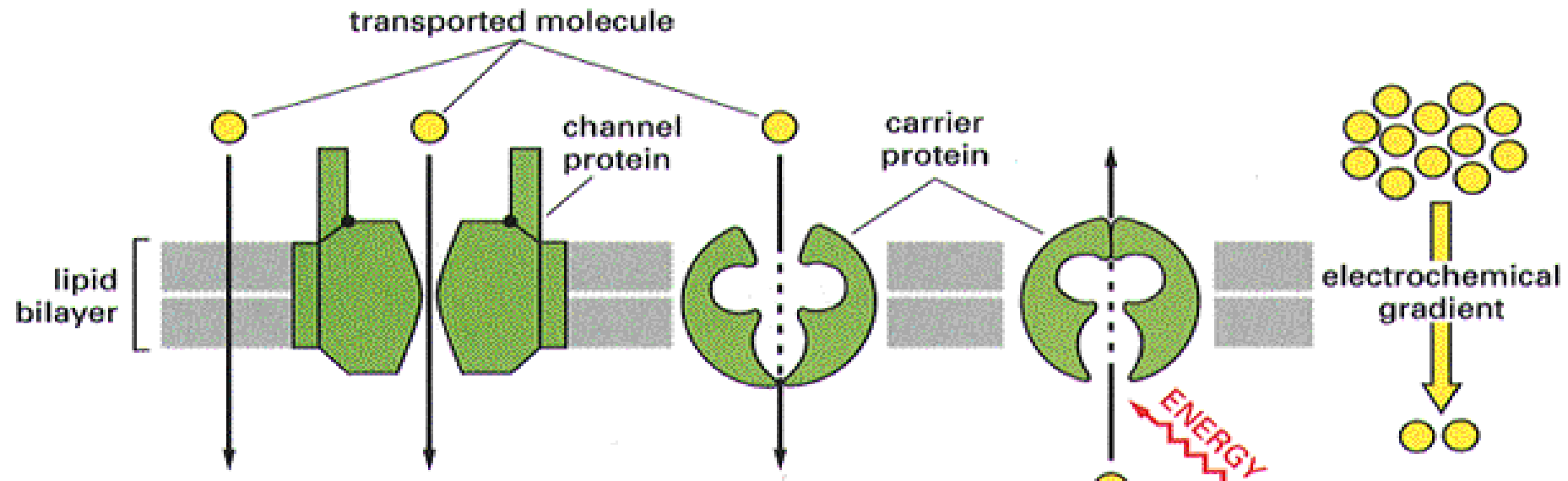

DIFFUSIONE
SEMPLICE
trasporto
passivo

CANALI IONICI
trasporto passivo

CARRIERS
trasporto passivo o
attivo secondario
(utilizzo indiretto di
A T P)

POMPE IONICHE
trasporto sempre attivo
primario (utilizzo diretto
d i A T P)

MEDIATED TRASPORT

“diagnostic characteristics”:

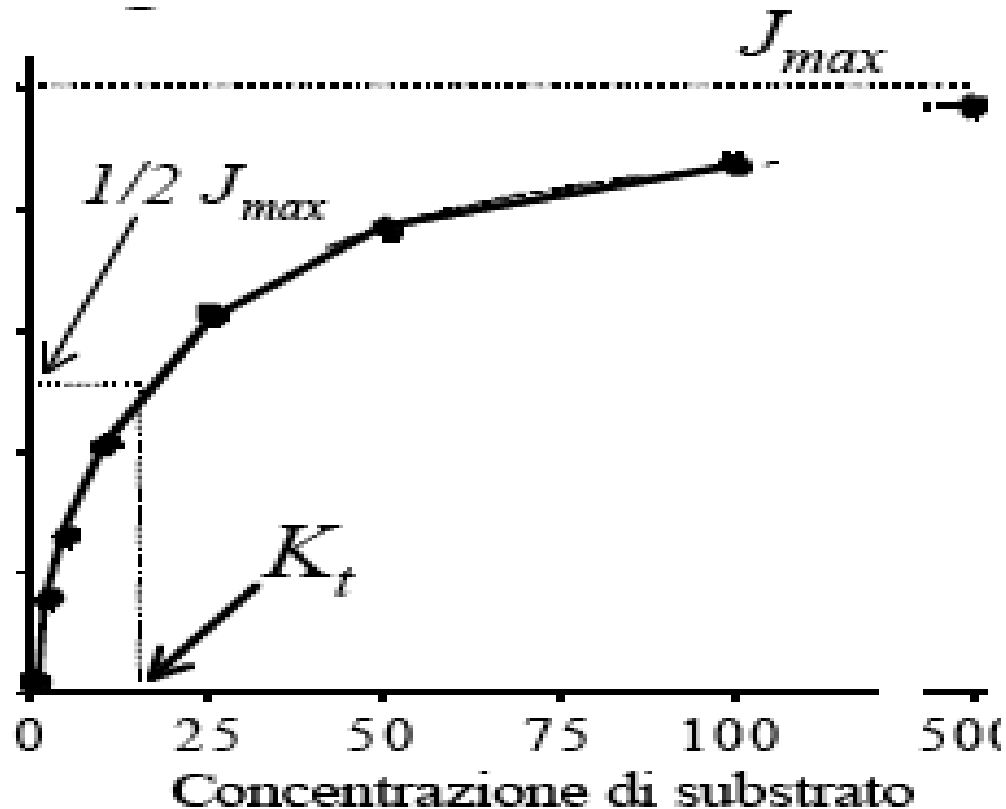

“SATURABILITY”

- Finite numbers of transporters
- Each carrier has its own properties and speed

$$J = \frac{J_{max} [S]}{K_t + [S]}$$

MEDIATED TRANSPORT

“diagnostic characteristics”:

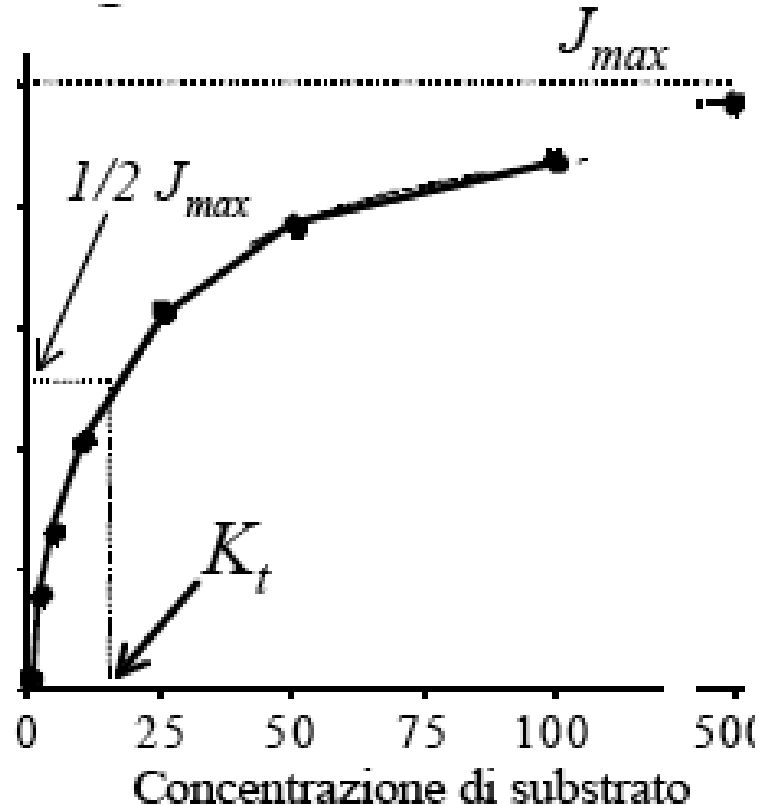

SPECIFICITY

Transporters are quite selective: as an example they are stereoselective (D-Gluc ma non L-Gluc; D-aa ma non L-aa)

In case the Transporter is able to recognize different molecules, the transport present the phenomenon of the “**competitive inhibition**” since different molecules can compete for the same binding site. In this case what changes is the K_t and not the J_{max} = to have the same flux it will be necessary a higher concentration of the substrate

If inhibitors bind the transporter blocking its activity, we can talk about **non competitive inhibitors** and they reduce the J_{max} value but not K_t = their effect is to reduce the number of functional transporters

Facilitated Diffusion

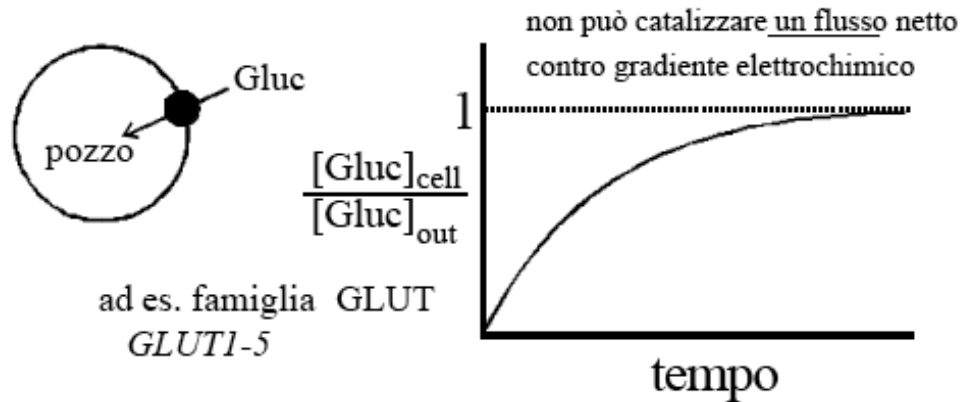

The regulation of the transporter can be achieved by:

- Changing the speed of the single transporters (as an example by phosphorylating cytoplasmic residues of the transporter)
- Changing the number of expressed transporters in the membrane

Glucose transporter (GLUT)

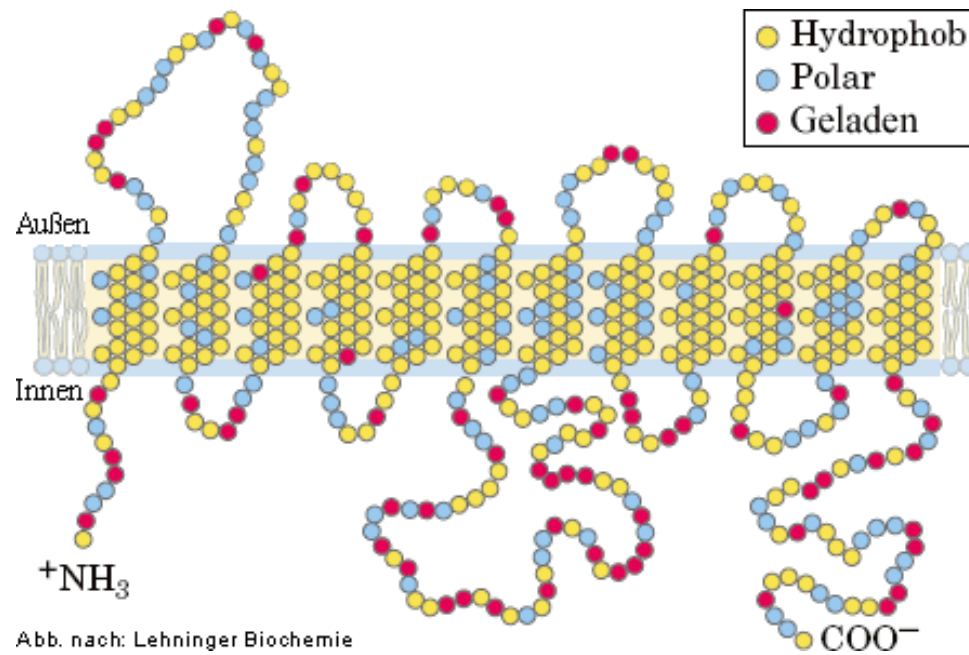

GLUT 1

- **GLUT-1** is the first transporter cloned. It is expressed at different levels depending on the glucose cellular metabolism. Ubiquitary expression
- **GLUT-2** expressed in hepatocytes, neurons and in the basolateral membranes of absorbing epithelia (such as in kidney and intestine)
- **GLUT-3**: neurons
- **GLUT-4**: adipose tissue and muscle. It's regulated by insulin

Basal

Figure 1

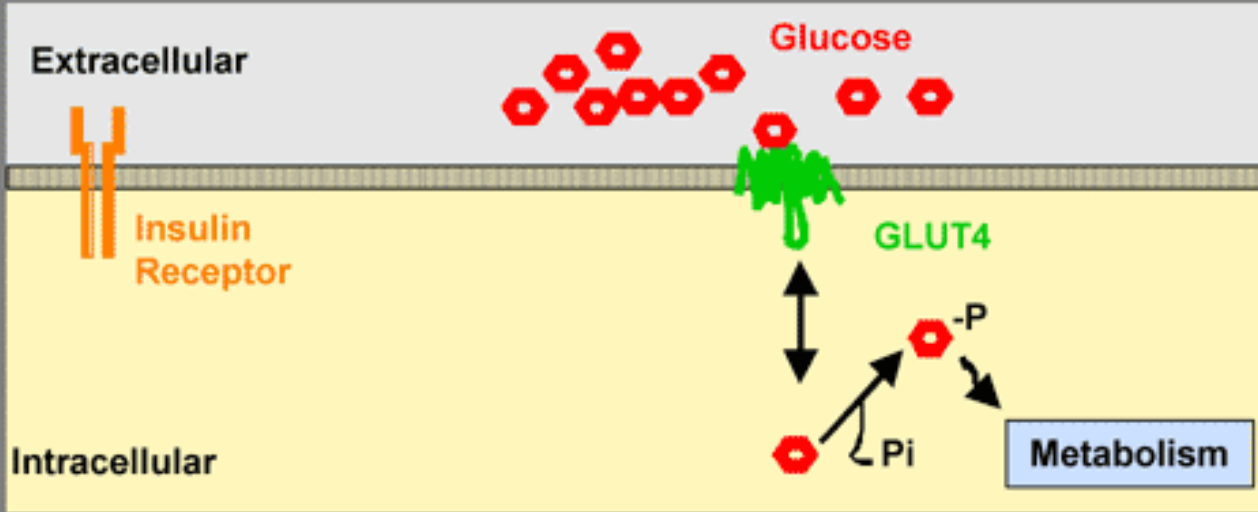

Insulin

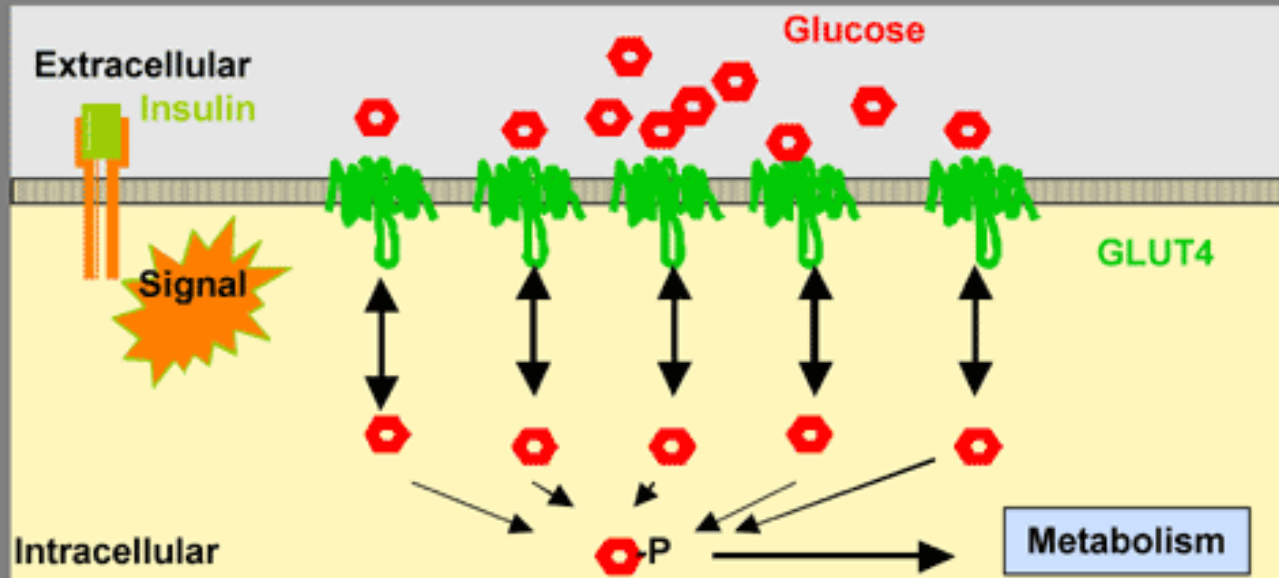

UNIVERSITÀ
TORINO

Department of
Life Sciences
and Systems Biology

ACTIVE TRANSPORT

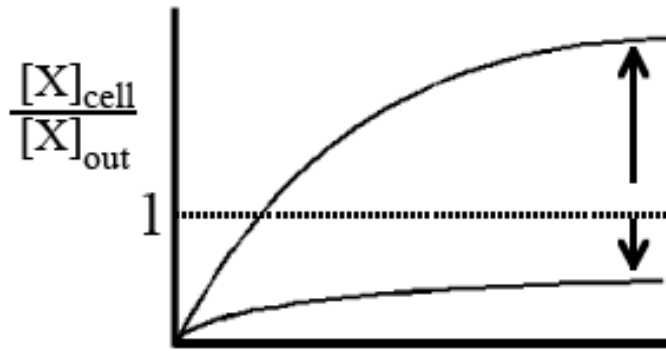

- Create and maintain transmembrane gradients of solutes
- Needs energy source
- Common features to facilitated transport:
 - Saturation
 - Inhibition and modulation

PRIMARY ACTIVE TRANSPORT: PUMPS; ATPase

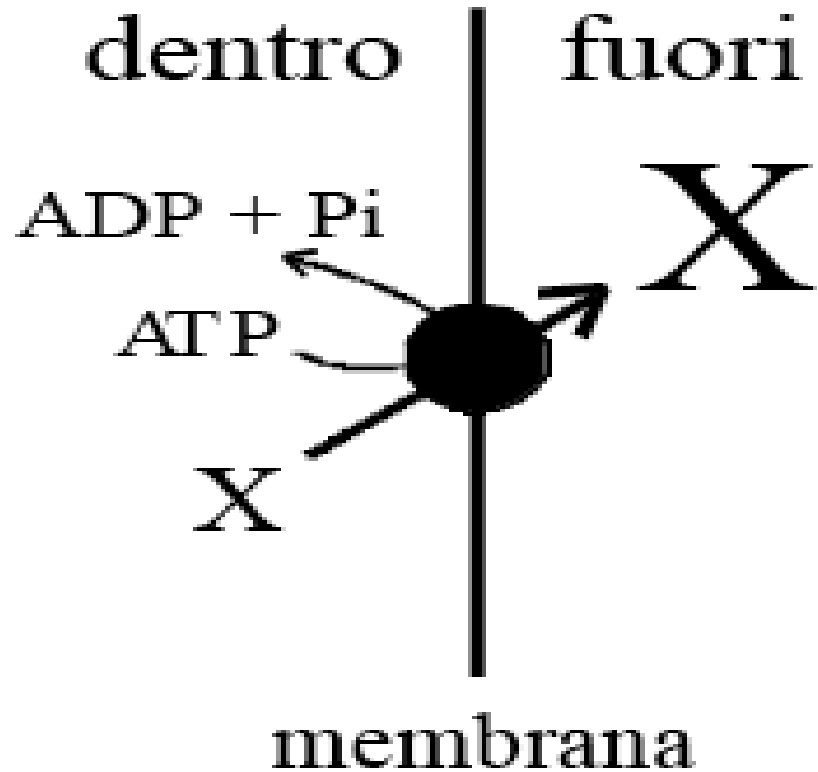

- X is one of the following inorganic cation:
- Na⁺
- Ca²⁺
- K⁺
- H⁺

Na⁺/K⁺ ATPase

- Use ATP to generate a gradient of Na⁺ and K⁺ concentration

- ELECTROGENIC PUMP :
- Transport proteins that use this mechanism of transport are designated as P types, since ATP cleavage is required and PO₃⁻ is covalently transferred to an Asp residue from the ATP.

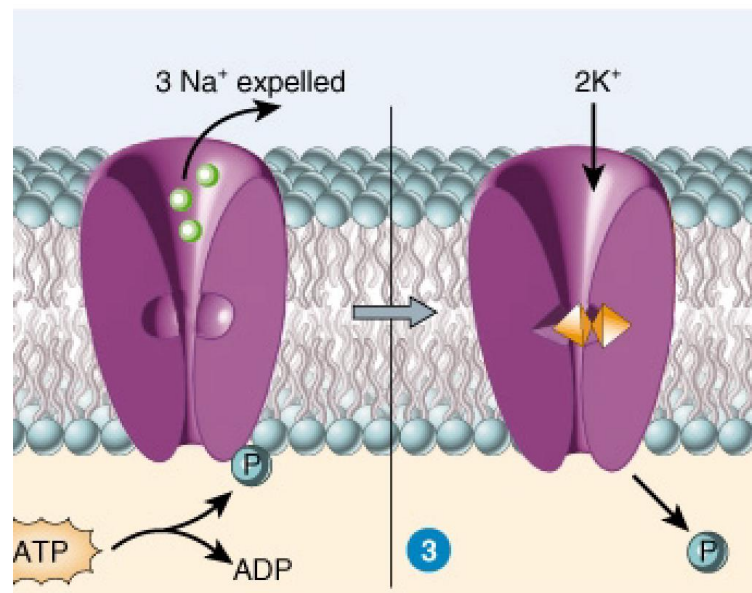

Na⁺/K⁺ ATPase

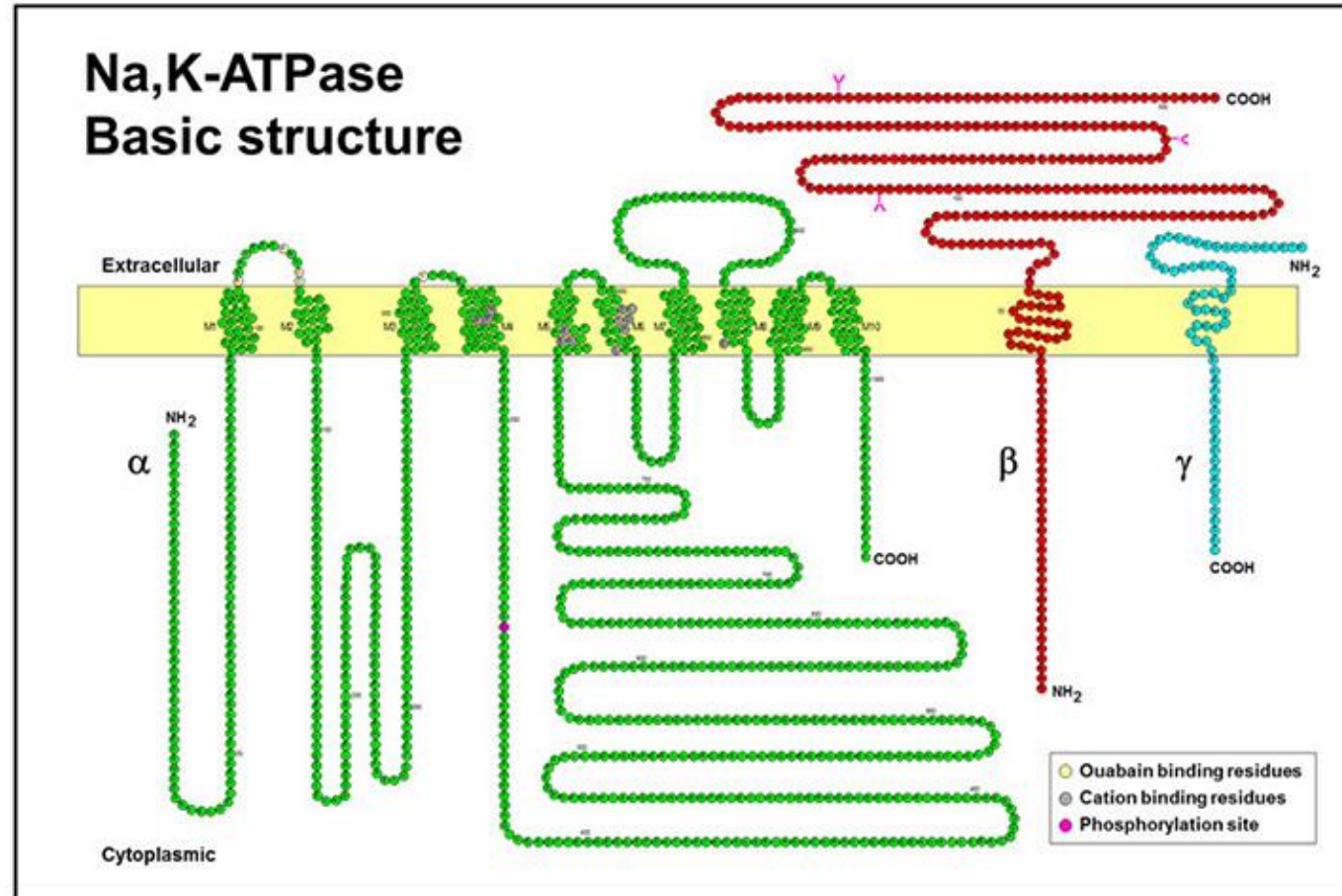

Activity cycle of Na⁺/K⁺ ATPase

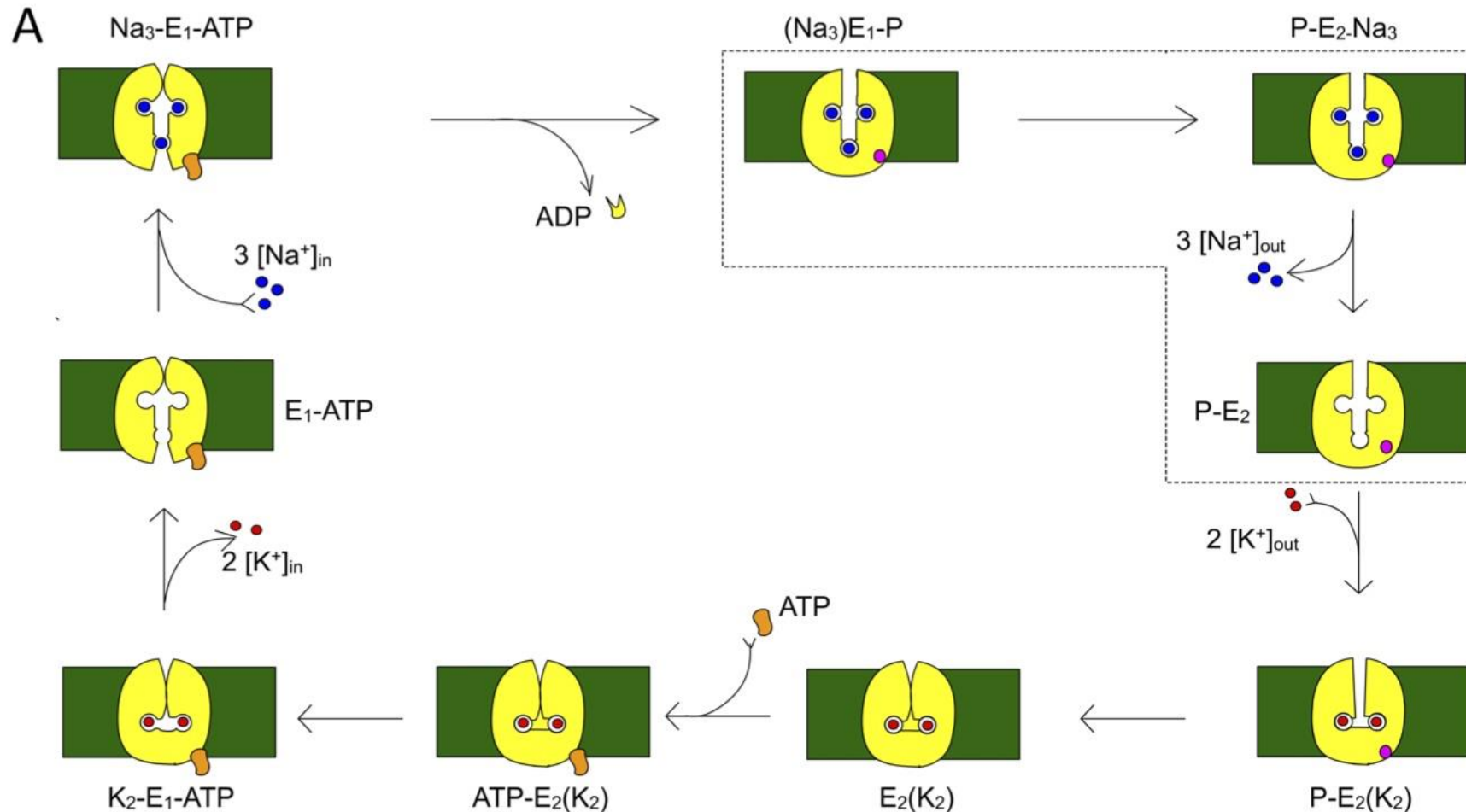

- The protein exists in two essential conformations, E1 and E2, depending on the phosphorylation state of the protein.
 E1= binding sites toward intracellular space
 E2= binding sites toward extracellular space

Activity cycle of Na⁺/K⁺ ATPase

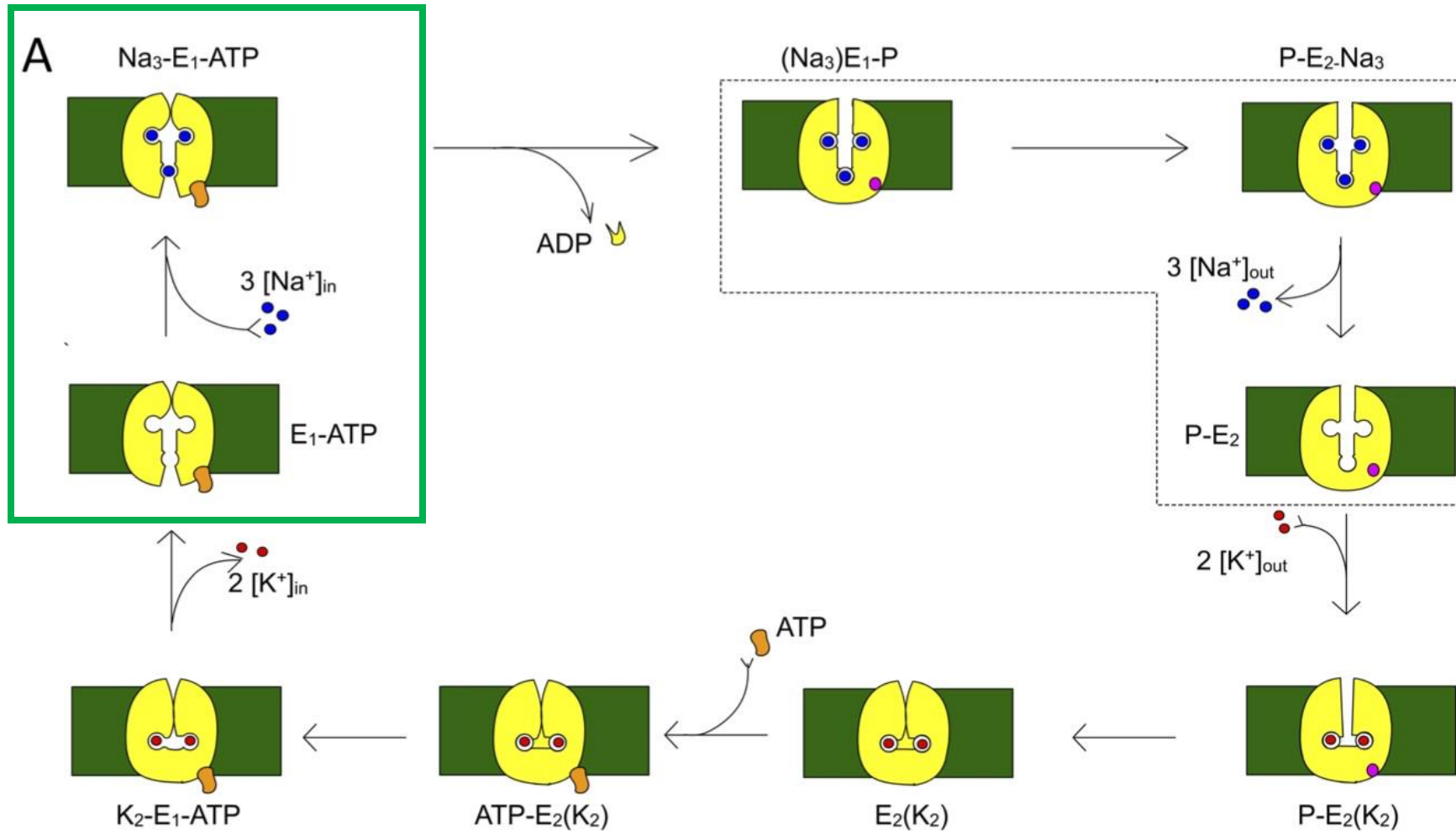

- ATP and 3 Na⁺ bind to the cytoplasmic domain of the enzyme in the E₁ conformation.

Activity cycle of Na⁺/K⁺ ATPase

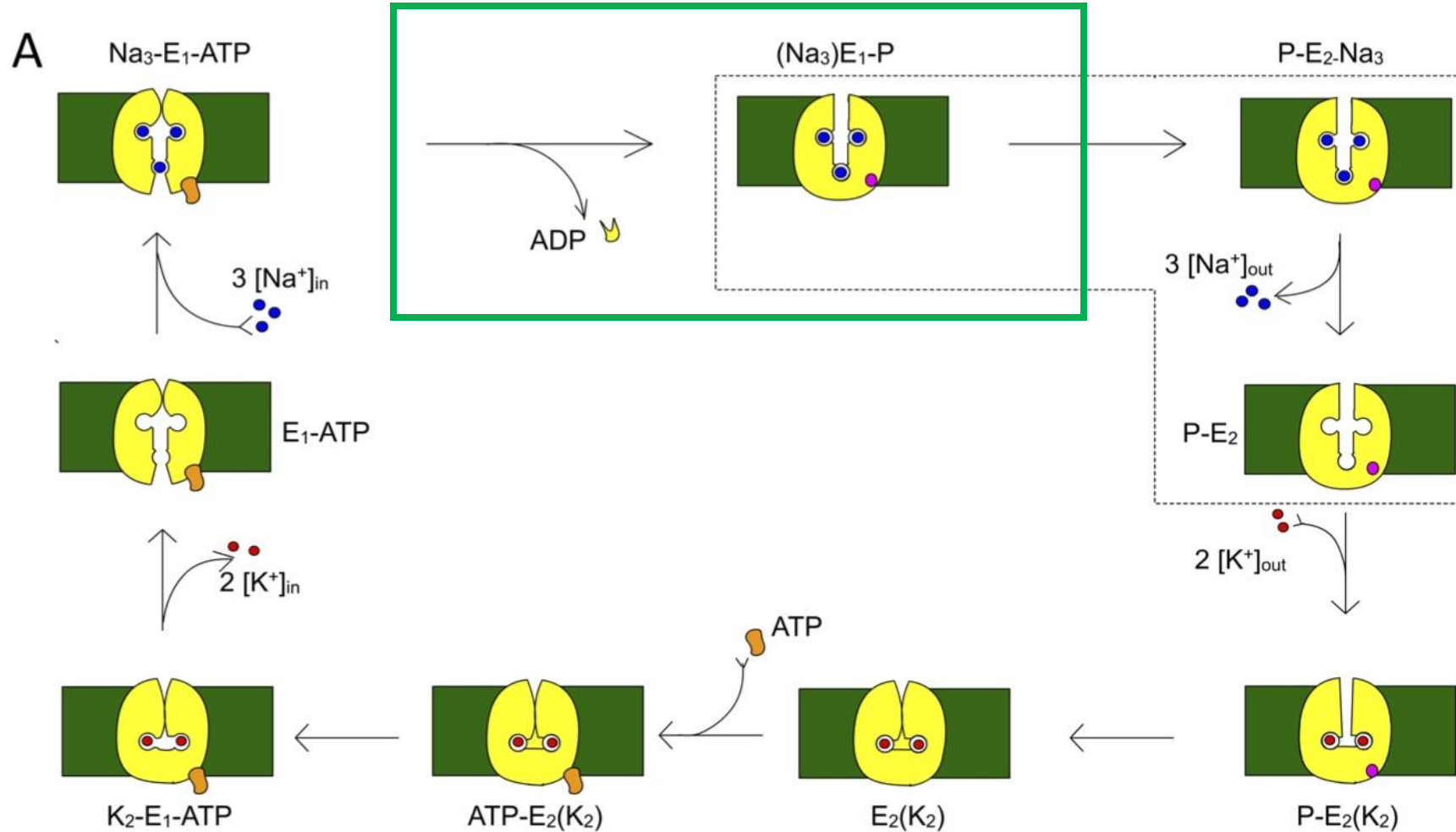

- In the presence of Na⁺ ions, the bound ATP is cleaved in a nucleophilic attack by an Asp side chain of the protein. (Hence, the protein is a Na⁺-activated ATPase.)

Activity cycle of Na⁺/K⁺ ATPase

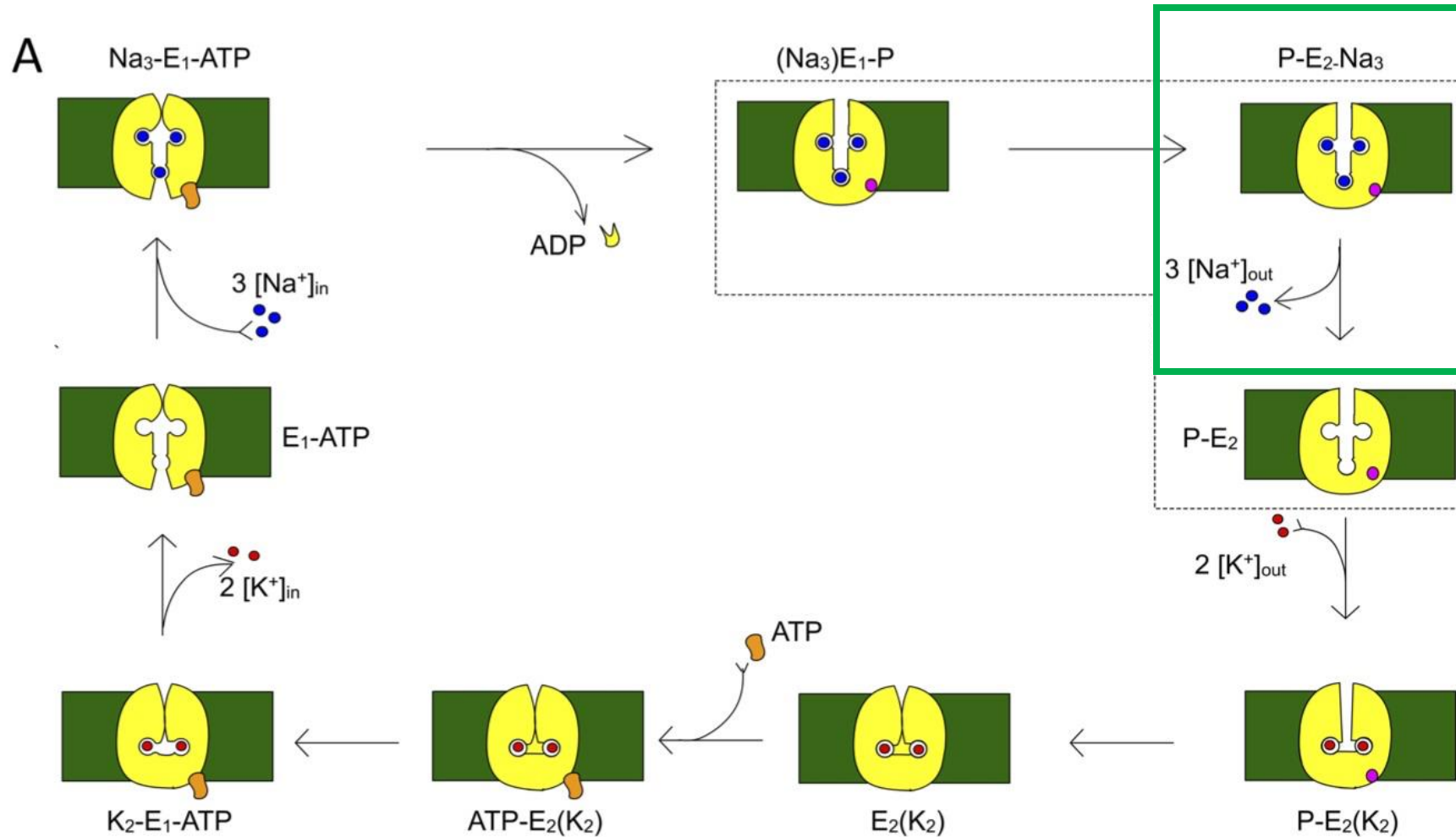

- The phosphorylated enzyme changes conformation to the E2 form in which Na⁺ ions are now on the outside of the cell membrane, from which they dissociate.

Activity cycle of Na⁺/K⁺ ATPase

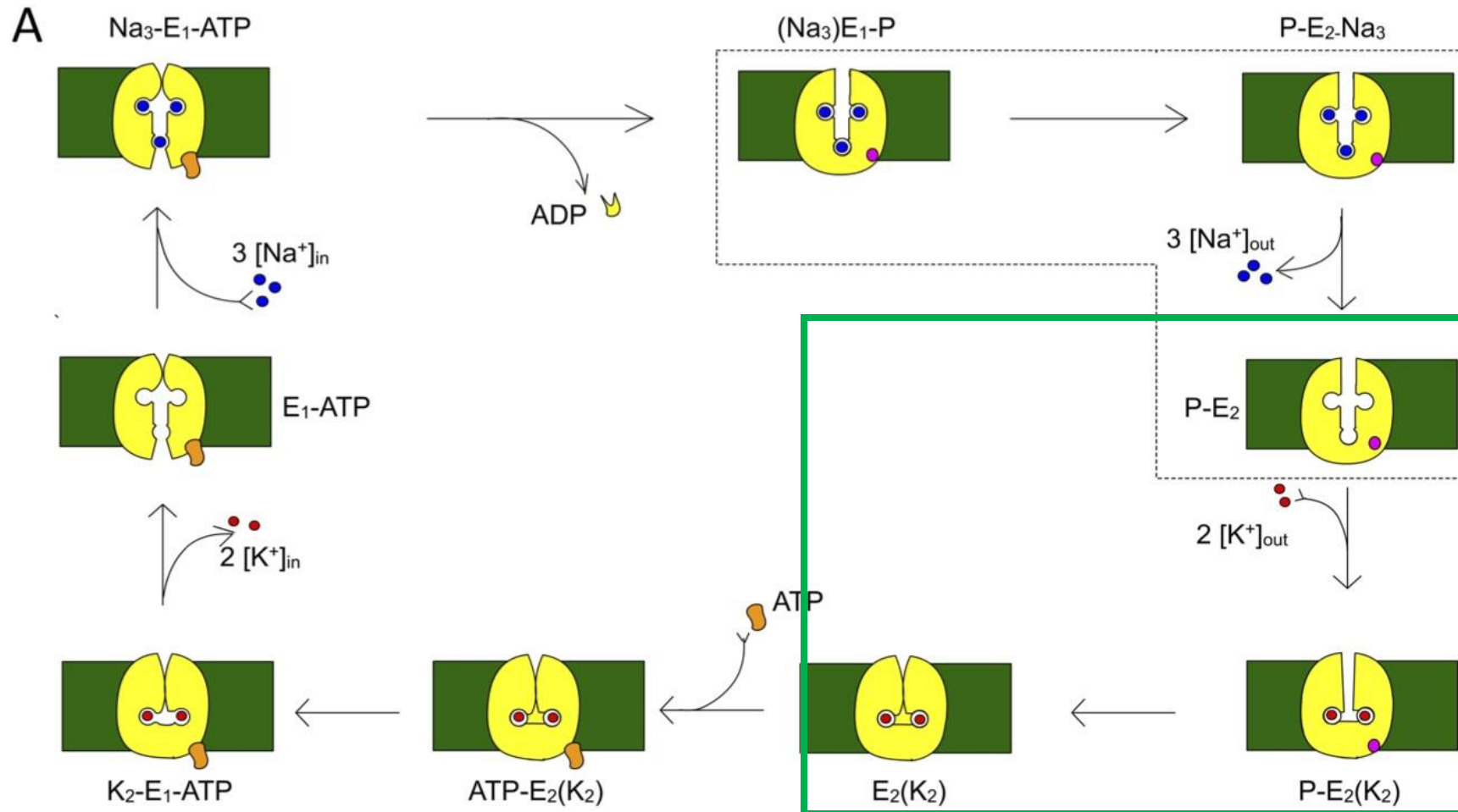

- The phosphorylated protein in conformation E₂ now binds 2 K⁺ ions on the outside, which activates hydrolysis of the Asp-PO₃ mixed anhydride link.

Activity cycle of Na⁺/K⁺ ATPase

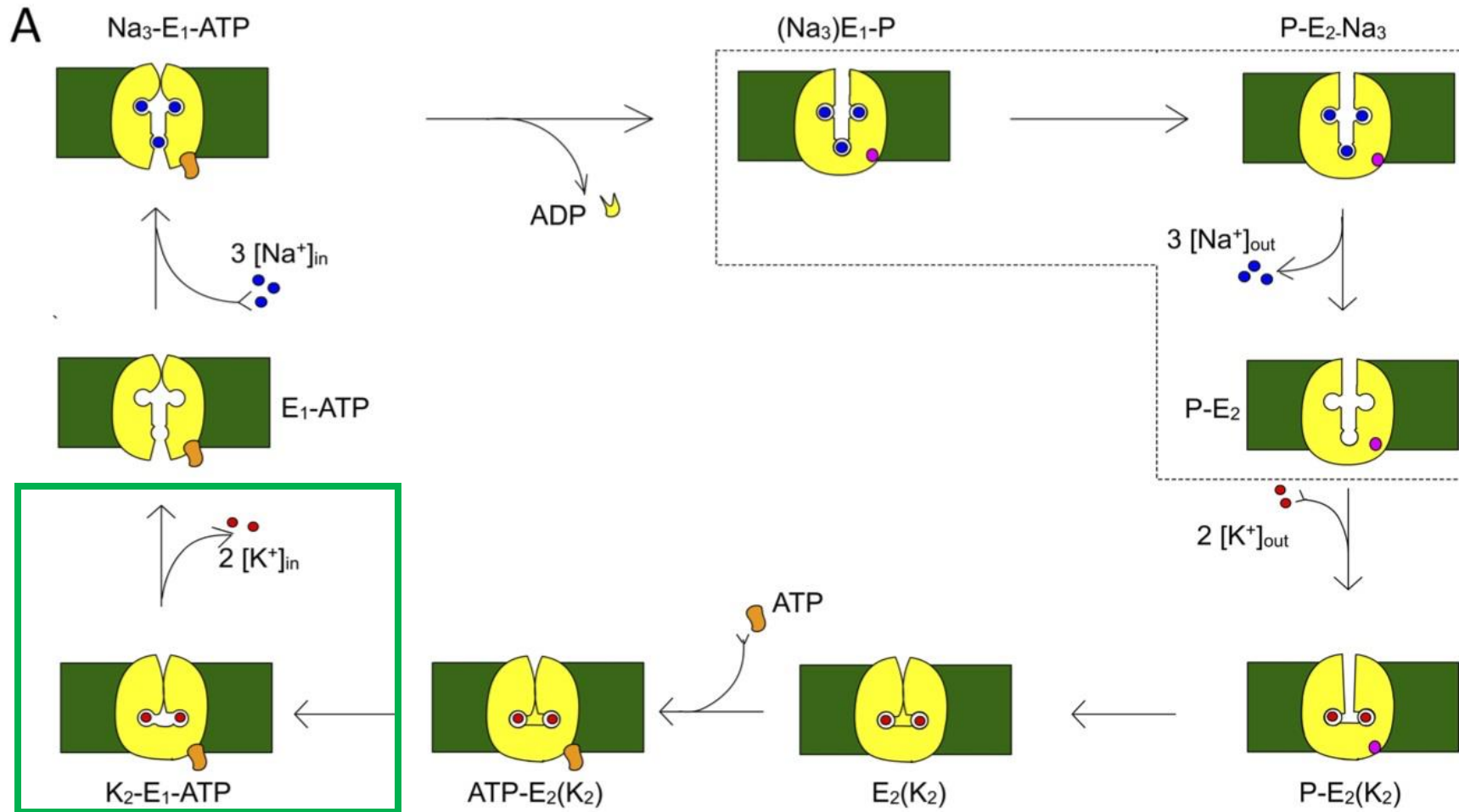

- The dephosphorylated protein is more stable in the E₁ conformation to which it changes as it brings K⁺ ions into the cell. Transport proteins that use this mechanism of transport are designated as P types, since ATP cleavage is required and PO₃⁻ is covalently transferred to an Asp residue from the ATP.

Activity cycle of Na⁺/K⁺ ATPase

- The protein exists in two essential conformations, E1 and E2, depending on the phosphorylation state of the protein.
- ATP and 3 Na⁺ bind to the cytoplasmic domain of the enzyme in the E1 conformation.
- In the presence of Na ions, the bound ATP is cleaved in a nucleophilic attack by an Asp side chain of the protein. (Hence, the protein is a Na⁺-activated ATPase.
- The phosphorylated enzyme changes conformation to the E2 form in which Na⁺ ions are now on the outside of the cell membrane, from which they dissociate.
- The phosphorylated protein in conformation E2 now binds 2 K⁺ ions on the outside, which activates hydrolysis of the Asp-PO₃ mixed anhydride link.
- The dephosphorylated protein is more stable in the E1 conformation to which it changes as it bring K⁺ ions into the cell. This is an example of an electrogenic antiporter. Transport proteins that use this mechanism of transport are designated as P types, since ATP cleavage is required and PO₃⁻ is covalently transferred to an Asp residue from the ATP.

Activity cycle of Na⁺/K⁺ ATPase

- Na⁺/K⁺ ATPase is activated in an asymmetric way from intracellular Na⁺ and extracellular K⁺ and NOT vice-versa.
- The 2 cation must be present at the same time in the two compartments to complete the cycle

- HORMONAL REGULATION:

Thyroid hormones induce α e β subunits synthesis therefore modulating the pump expression in tissues

Aldosterone trigger gene transcription of both the subunits

Insulin plays a double role: short term regulation on pump activity and long term regulation on the synthesis

Other ATPase

- Ca^{2+} ATPase: role in maintaining the low intracellular Ca^{2+} concentration (10^{-4} M) (PMCA o SERCA)
- $\text{H}^{+}/\text{K}^{+}$ ATPase promotes gastric acidification
- V-ATPase pump protons acidifying intracellular organelles such as lysosomes or vacuoles in plant cells
- ABC Transporters (ATP Binding Cassete). An example is MDR (multi drug resistance) which pumps actively cytotoxic drugs out of the cell

Struttura delle pompe di tipo P

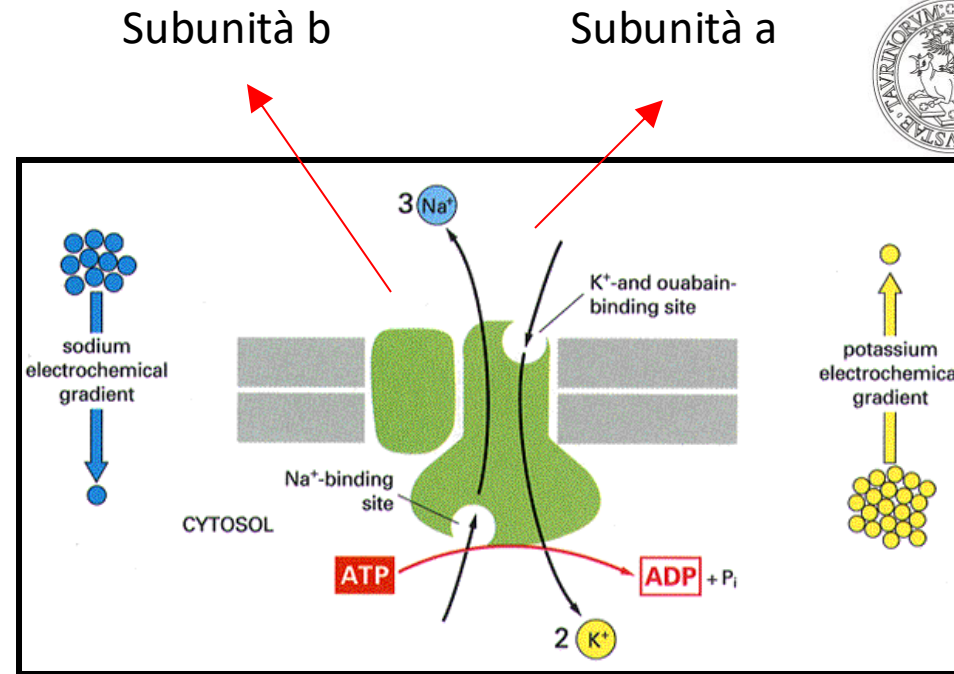

pompa del Ca del reticolo
endoplasmatico (SERCA)

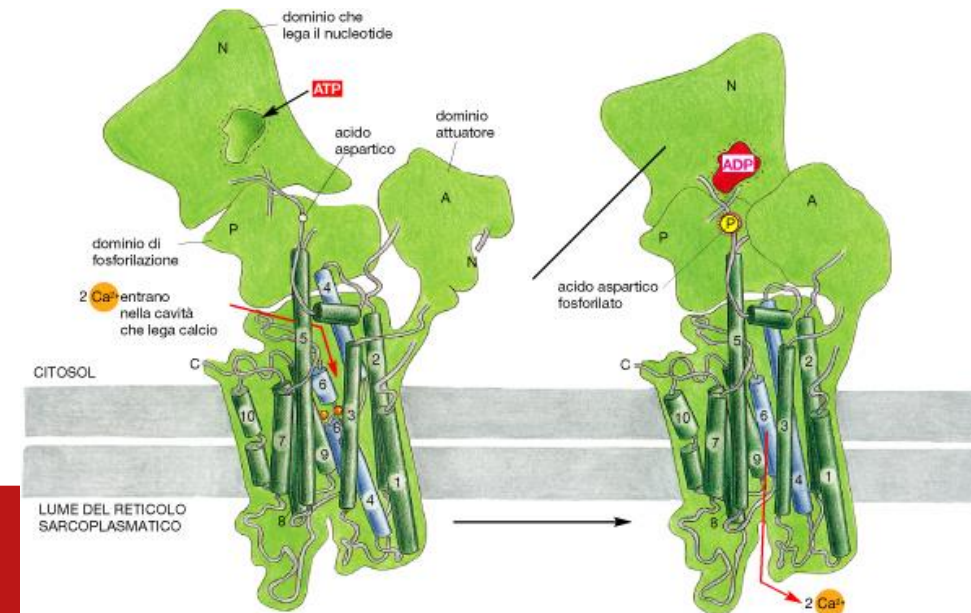

Active Secondary Transports: symport and antiport

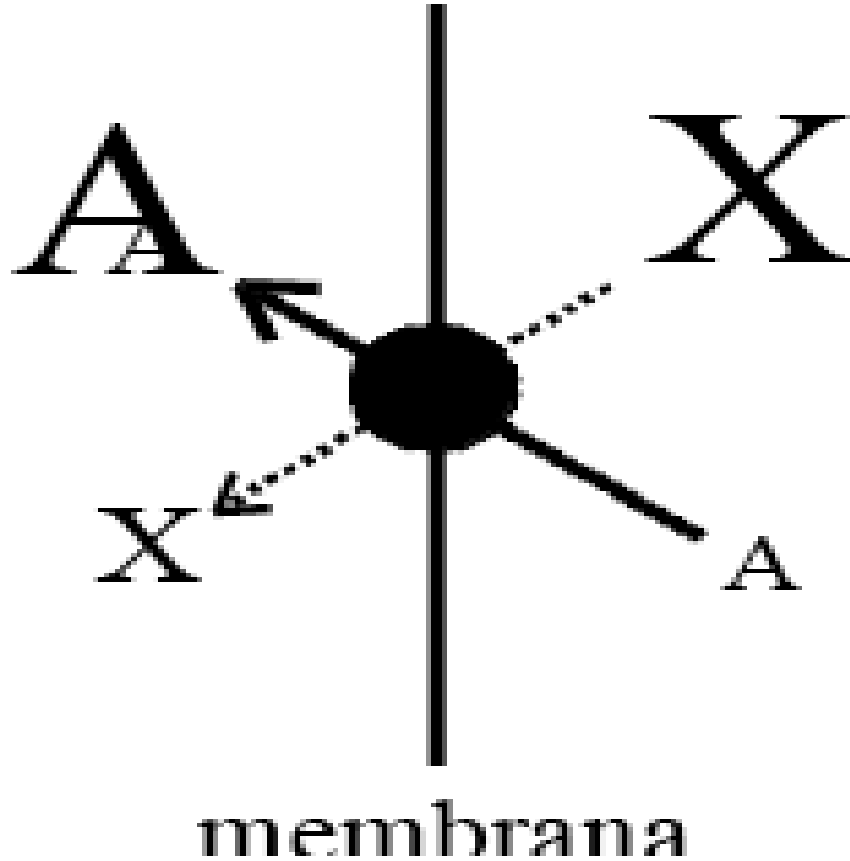

- The use of active secondary transports is a common strategy used to accumulate organics and inorganic nutrients and small molecules
- X is typically Na^+ (but also H^+). It is not surprising therefore that Na^+ and H^+ gradients are maintained by active transports
- It has the same characteristics of Facilitated Transports but more complex since there are 3 species playing role: the transporter, the substrate and the driver

Secondary Active Transports: Symport and antiport

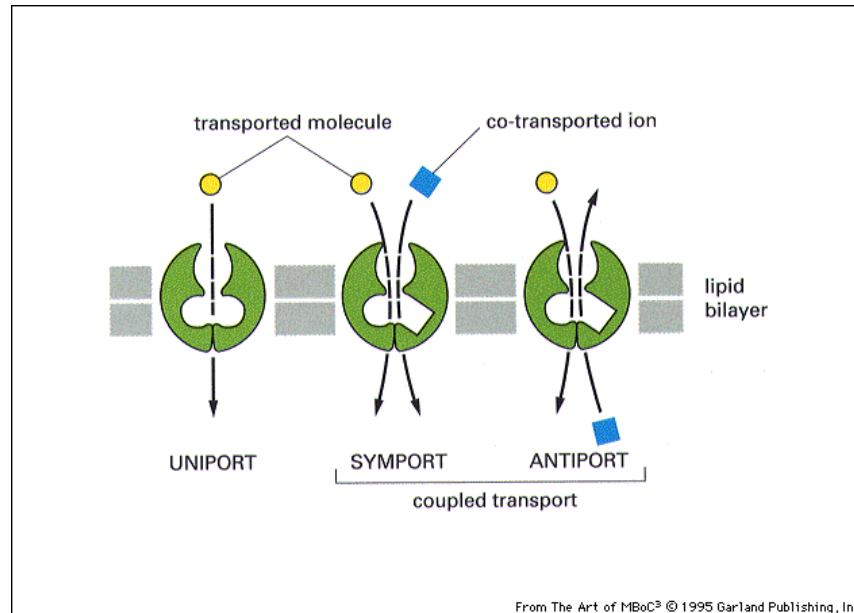

- The electrochemical gradient of Na^+ (created by Na^+/K^+ ATPase) is used to transport molecules such as glucose (SGLT) or aa
- Cotransporters which are involved in neurotransmitter recycle: Na^+/Cl^- dependent transporters; Excitatory amino acid transporters (EAAT)

- Antiports Na^+/H^+ and $\text{Na}^+/\text{Ca}^{2+}$ use Na^+ influx to remove H^+ e Ca^{2+} from the cytosol

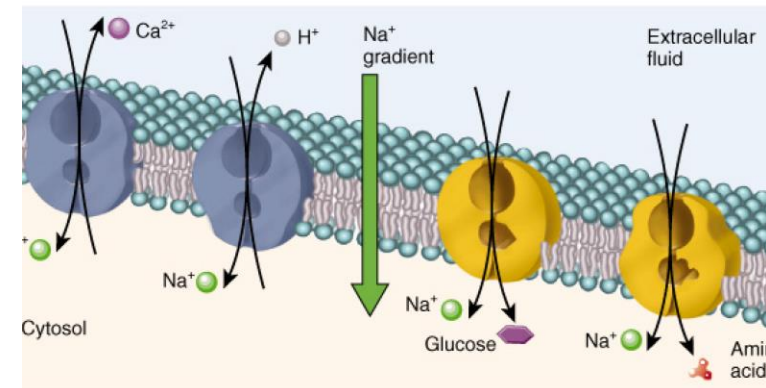

SGLT

- SGLT are responsible of glucose reabsorption from intestine and kidney

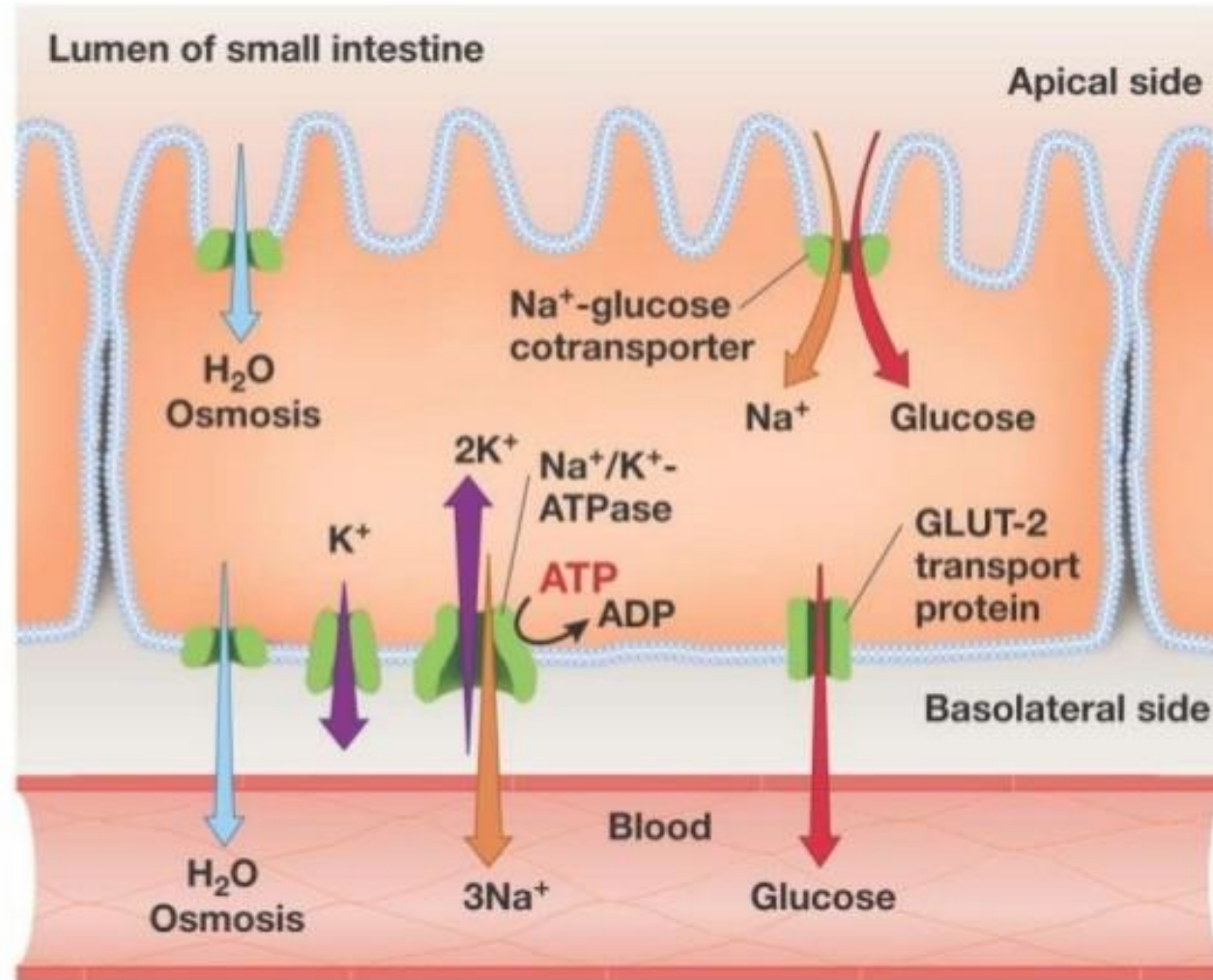

SGLT

- SGLT are responsible of glucose reabsorption from intestine and kidney

Insieme alla biologia molecolare, ha permesso di identificare il significato funzionale di precise sequenze aminoacidiche.

ES: malattia genetica recessiva che impedisce l'assorbimento intestinale del Glu e Gal, e' causata da mutazioni puntiformi del trasportatore (**Asp28Asn**) causa malassorbimento intestinale

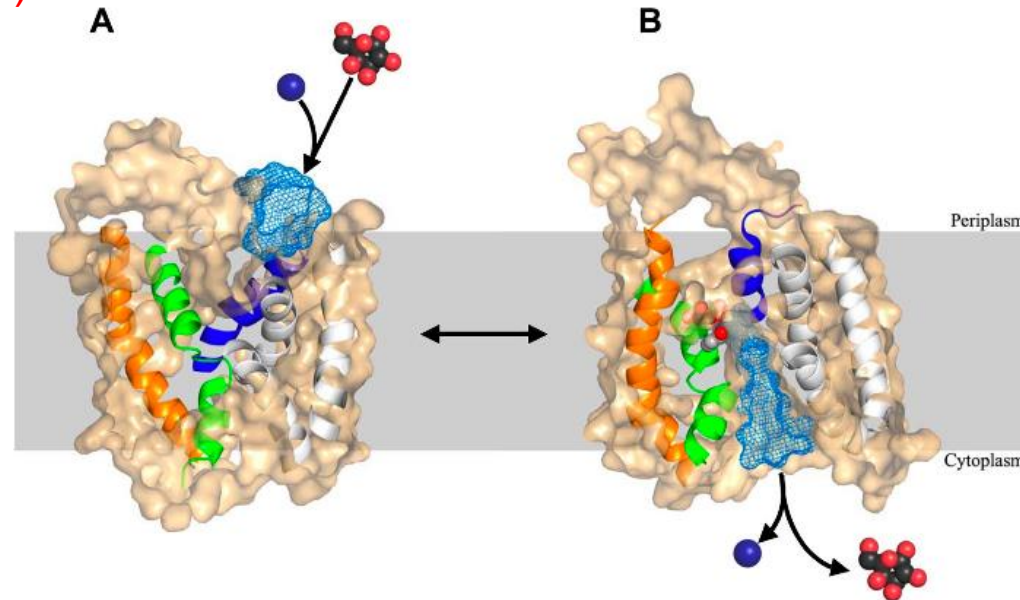

Na⁺/GLUC transporters (SGLT)

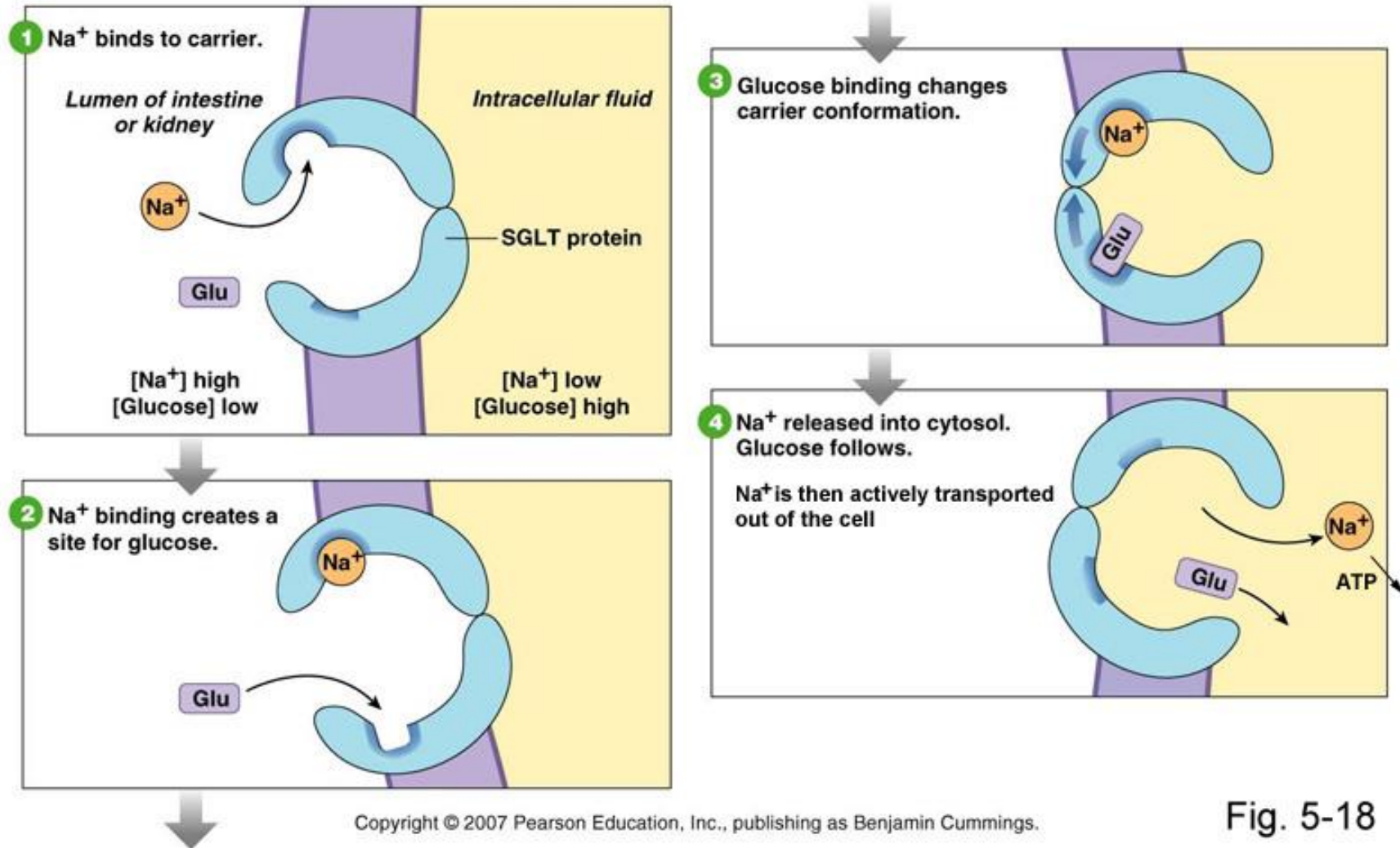

Neurotransmitters co-transporters

Key role in neurotransmitters removal from post synaptic space.

(This role is also accomplished by specific enzymes).

Two main classes of cotransporters for neurotransmitters:

- NA⁺/CL⁻ DEPENDENT TRANSPORTERS
- EXCITATORY AMINOACID TRANSPORTERS (EAAT)

- **NA⁺/CL⁻- DEPENDENT TRANSPORTERS**

Classical example

GABA transporters GAT: remove GABA (the principal inhibitory neurotransmitter in the CNS).

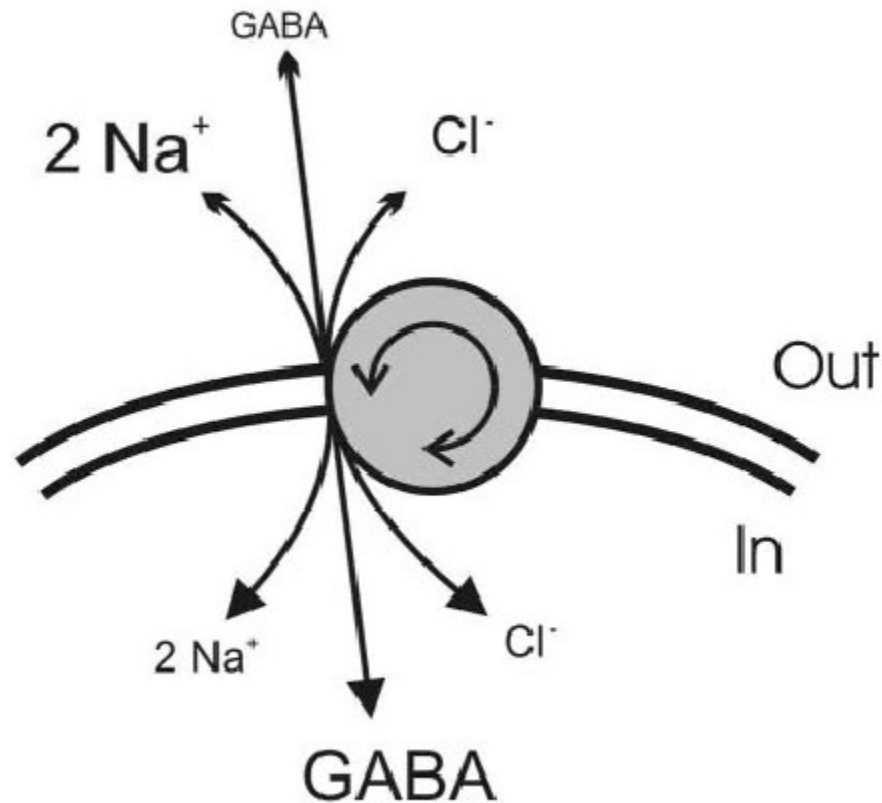

The uptake of GABA is dependent upon the coupled translocation of 2Na⁺ and 1Cl⁻ and thus the net uptake of one positive charge.

• NA^+/CL^- -DEPENDENT TRANSPORTERS

This family of transporters also comprehends:

Proline (PROT) and Glycine (GLYT) transporters

Dopamine (DAT) transporters

Serotonin (SERT)

Noradrenalin (NET)

All these transporters are targets for narcotic drugs and psychotropic substances

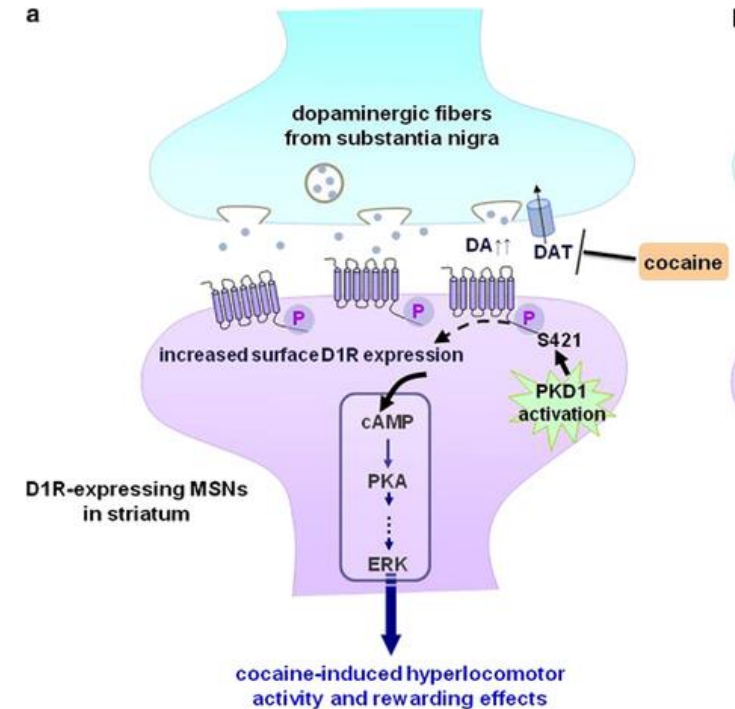

EXCITATORY AMINOACID TRANSPORTERS (EAAT)

Glutamate transport by EAAT1, 2, and 3

is coupled to the cotransport of 3 Na⁺ and 1 H⁺ followed by the countertransport of 1 K⁺.

At equilibrium under standard physiological conditions, this coupling ratio is able to support a **106 fold gradient** of glutamate across the cell membrane. Theoretically, this coupling ratio should ensure that the resting extracellular glutamate concentration should be in the low nanomolar range.

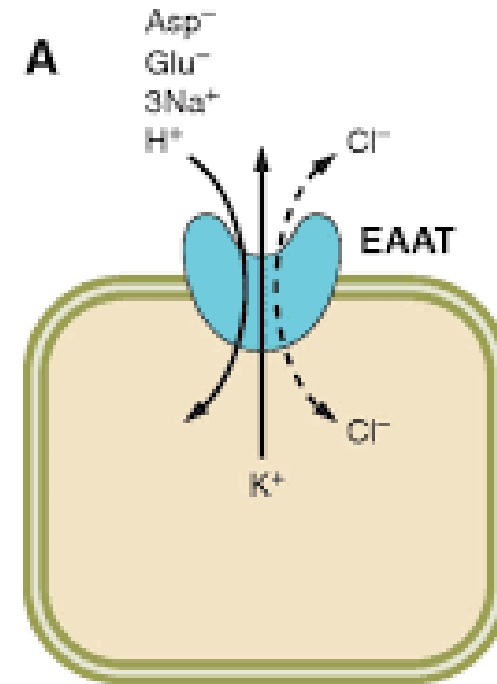

EXCITATORY AMINOACID TRANSPORTERS (EAAT)

In addition to the coupled glutamate ion fluxes, substrate binding to the EAATs generates a chloride (Cl^-) flux through the transporter. The extent of channel activity varies between transporter subtypes. The neuronal transporters EAAT4 and EAAT5 behave predominantly as Cl^- channels, while for EAAT1, EAAT2, and EAAT3 the channel activity represents a much smaller proportion of the ion fluxes associated with transporter function.

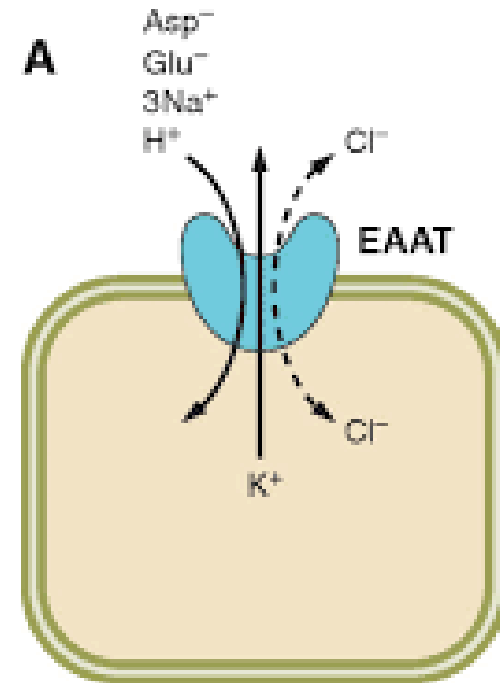

AMINOACID TRANSPORTERS

Amino acids fundamental for cell metabolism cross the plasma membrane by means of UNIPORTERS, crossing the membrane along their gradient, or CONTRANSPORTERS, crossing the membrane against their gradient.

The main criteria for the classification of the Amino acid Transporters is based on aa types. We therefore can divide the transporters in 3 main categories:

- Neutral amino acid Transporters
- Positive charged amino acid Transporters
- Negatively charged amino acid Transporters

The ubiquitous expressed aa Transporters are generally poorly selective: broad selectivity for different α -amino acids.

On the other hand the neurotransmitters transporters expressed at synaptic level are highly selectivity for their specific substrate (as shown earlier)

AMINOACID TRANSPORTERS

Another criteria for the classification of the Amino acid Transporters is based on molecular structure.

Using this classification criteria we can enumerate:

- EAAT Transporters (Excitatory aa transporters) = Na⁺/Cl
- SNAT (Na⁺-coupled neutral aa transporters)

This family accounts for both neutral aa and small polar aa such as Asparagine (Asn) or Glutamine (Gln). Important role in several processes such as Gln recycling for GABA synthesis, NH₃ detoxification, liver gluconeogenesis, acidosis response in kidney

- CAT (cationic-Na⁺ aa transporters) mediate transmembrane fluxes of aa such as Arginine (Arg), Lysine (Lys), Histidine (His). Important role in NO synthesis
- HAT (heteromeric aa transporters) are formed by 2 different subunits. They transport neutral or basic aa

Absorbent Epithelial structure

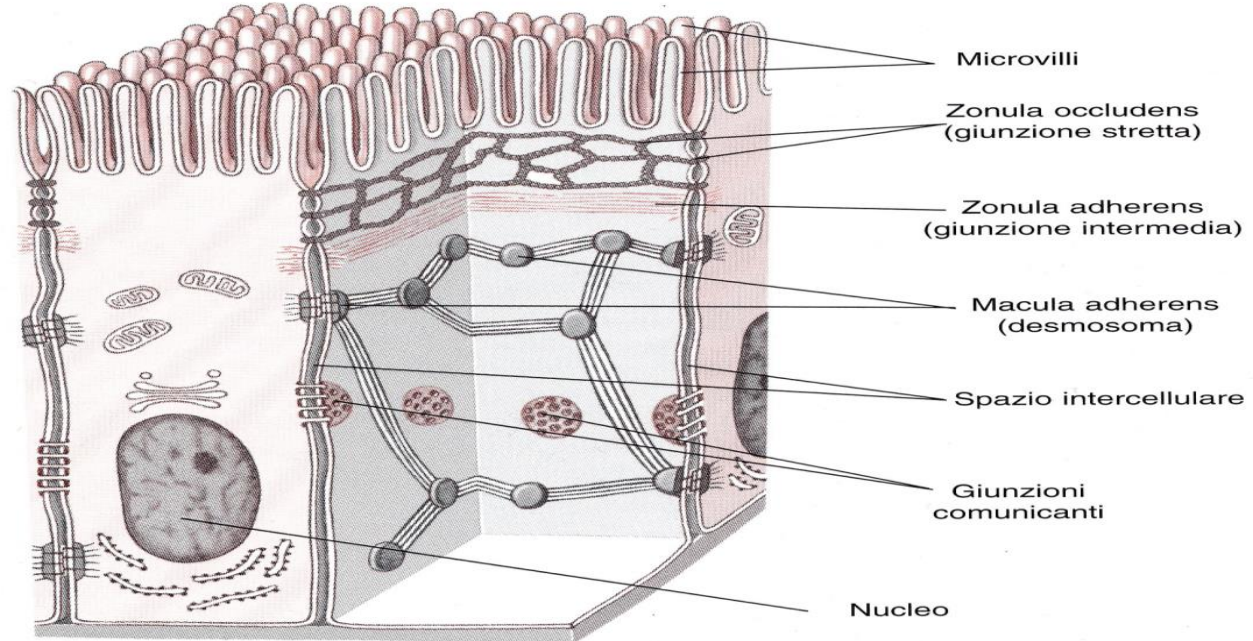

- Cell-cell contact is mainly due to tight junctions which limit the flow of material therefore delimiting the two epithelial faces.

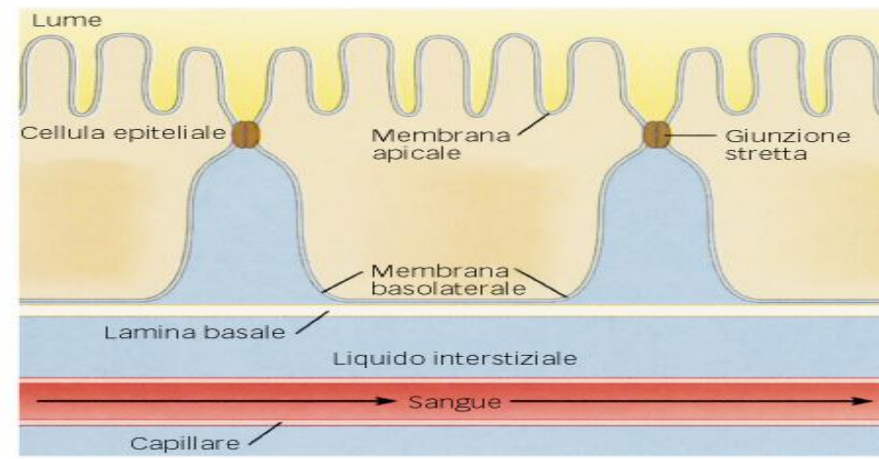

Absorbent Epithelial structure

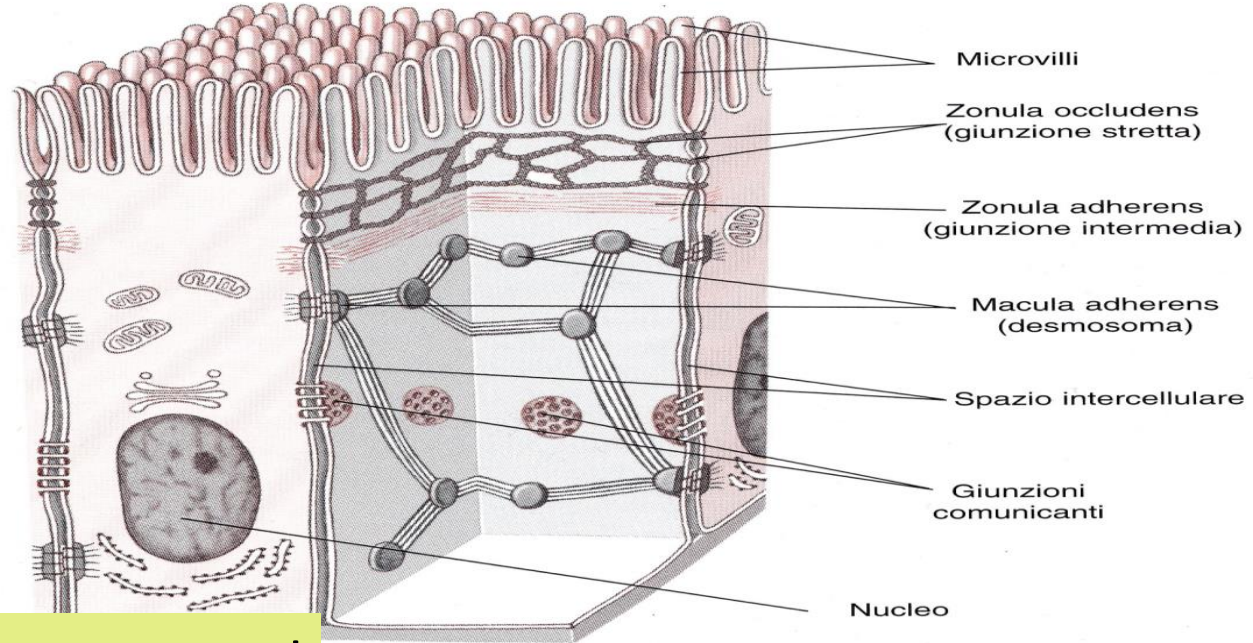

- **Apical membrane** toward the internal lumen. Often presenting microvilli that amplify the exchange surface. In this domain there is a large number of enzymes, uniporters and cotransporters

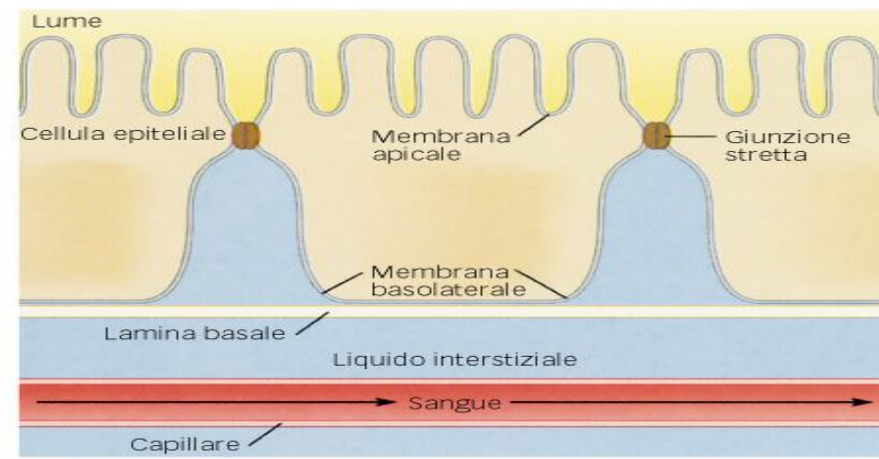

Absorbent Epithelial structure: Polarized epithelia

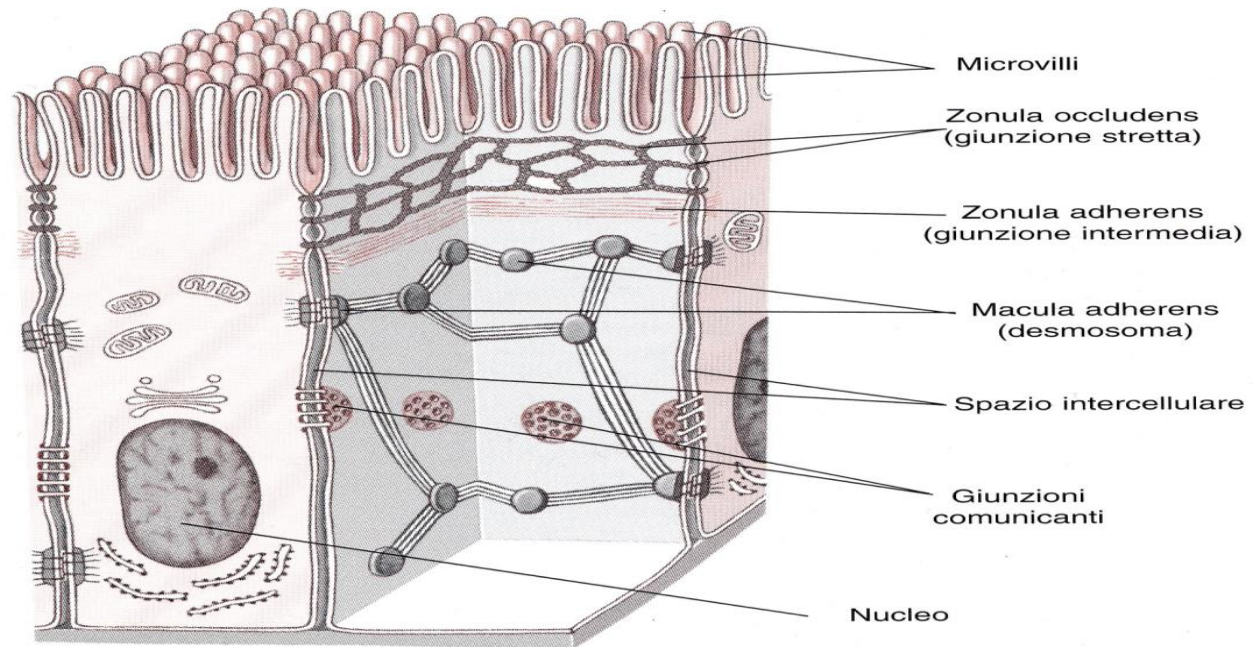

• **Basolateral Membrane** toward the internal part of the body is in contact with the interstitial liquid exchanging substances with blood circulation. Is characterized by the presence of Na^+/K^+ ATPase that is absent in the apical membrane

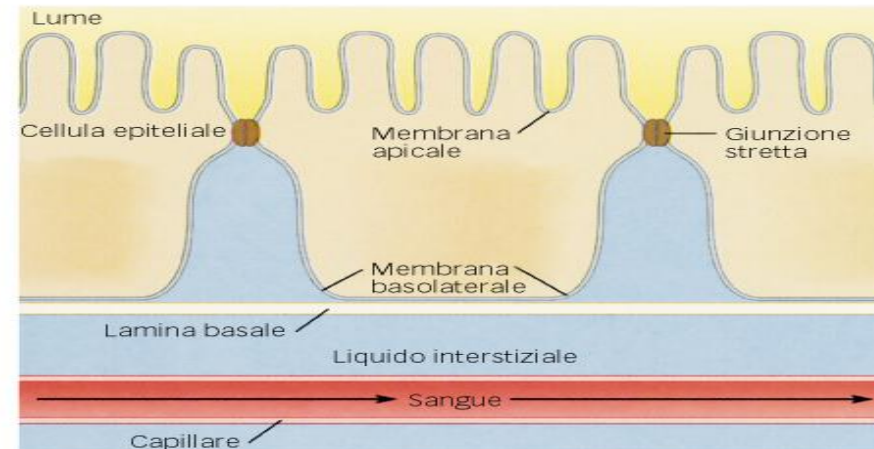

• 2 types of transports

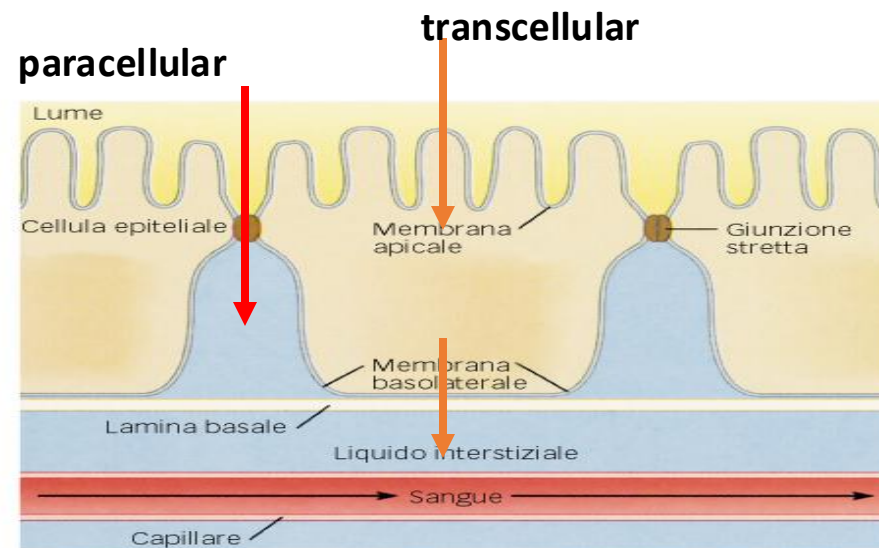

- **Paracellular fluxes:** Passive diffusion of ions (Na^+ , Cl^- , K^+ , Ca^{2+} , Mg^{2+}) and H_2O .

In absorbent epithelia, this way is limited by the presence of tight junction

- **Transcellular fluxes:** fluxes of ions and small molecules mediated by transporters

Composed by:

- Passive or secondary active transporters on apical membranes
- Active Transports (Na^+/K^+ -ATPasi) and other passive or active transports on basolateral membranes

Intestinal Na^+ Absorption



Apical membrane:

- Passive transport of Na^+ (Na^+/H^+ antiport; Na^+/aa or $\text{Na}^+/\text{K}^+/\text{2Cl}^-$ -cotransports)

Basolateral membrane:

- Active Transport Na^+ e K^+ (Na^+/K^+ -ATPase)
- Passive transport K^+ and Cl^- (ion channels)

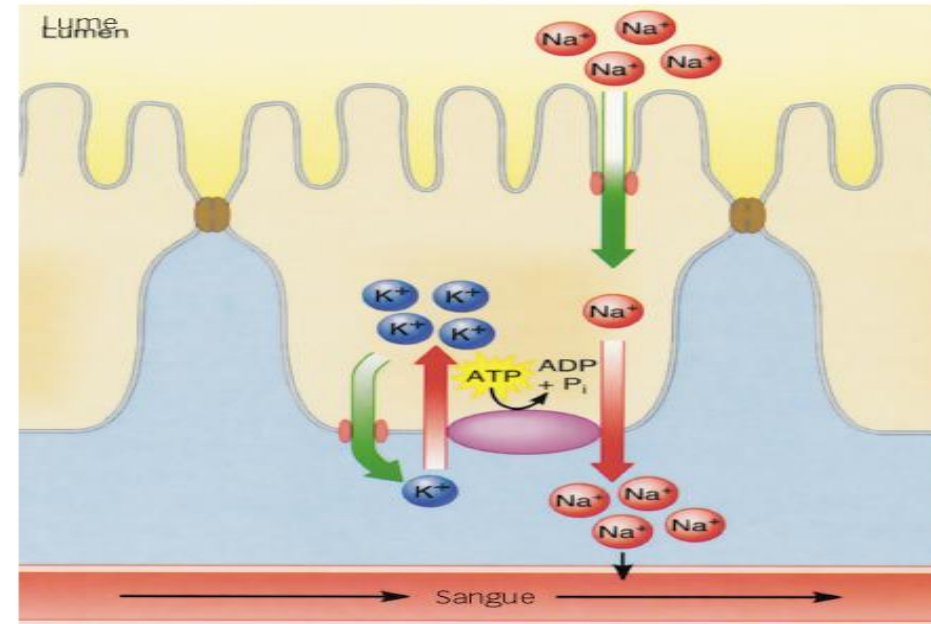

(a)



Net absorption of NaCl

Intestinal Na^+ and Glucose Absorption



UNIVERSITÀ
DEGLI STUDI
DI TORINO

Apical Membrane

- Secondary active Transport of Na^+ and glucose (SGLT)

Basolateral Membrane

- Active Transport Na^+ and K^+ sulla m. basolaterale (Na^+/K^+ -ATPase)
- Passive Transport for glucose (GLUT) and K^+ (ion channels)

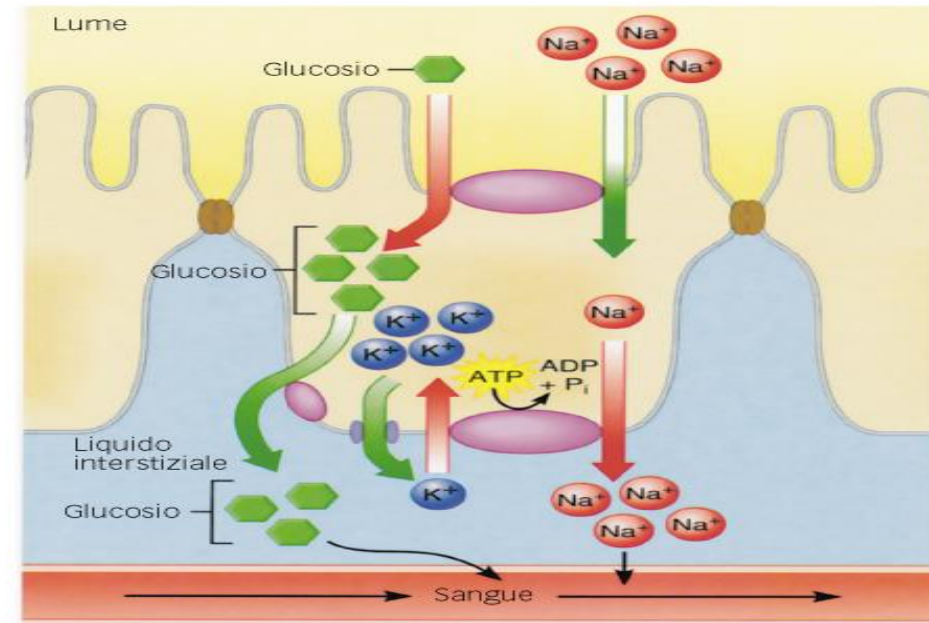

(b)

Role of coupled fluxes across the epithelia



UNIVERSITÀ
DI TORINO

Department of
Life Sciences
and Systems Biology

- Fluxes depends on coupled forces and simmetric crossed coefficients
- H₂O fluxes brings solutes
- Solutes fluxed influence H₂O movements
- The net fluxes are dependent on energy sources : most of the times Na⁺ gradient which is created by 3Na/2K ATPase

Patologie del trasporto epiteliale: la fibrosi cistica



In alcune condizioni patologiche il trasporto epiteliale di H_2O è eccessivo o insufficiente:

- Nella **fibrosi cistica** l'epitelio che riveste le vie respiratorie non trasporta abbastanza soluti (Na^+ e Cl^-) per produrre liquidi.
- Un difetto del **canale del Cl^- (CFTR)** interferisce con il trasporto del Na^+ , viene meno il gradiente osmotico e quindi la secrezione di acqua.
- I polmoni si intasano di muco rendendo difficile la respirazione e portando gravi infezioni batteriche.

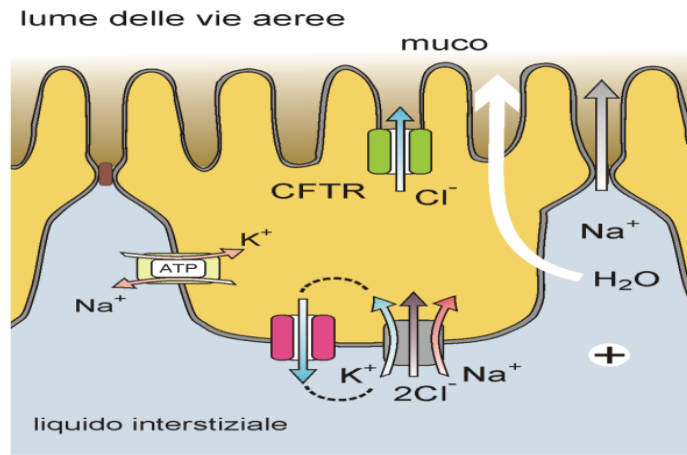

Trasporto di Cl^- , Na^+ e H_2O per la normale produzione di muco

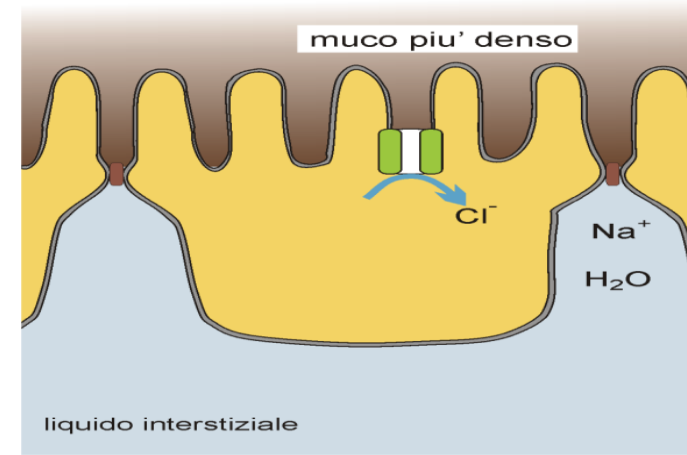

Trasporto di Cl^- , Na^+ e H_2O compromesso nella fibrosi cistica (CFTR non funzionante) con conseguente aumentata densità di muco nelle vie aeree

Assorbimento di soluti e H₂O

- Gli epitelii assorbono (o secernono) H₂O utilizzando il trasporto attivo di soluti.
- Si crea prima un **gradiente osmotico** tra le soluzioni poste ai due lati dell'epitelio
- L'H₂O quindi fluisce passivamente attraverso l'epitelio per **osmosi**

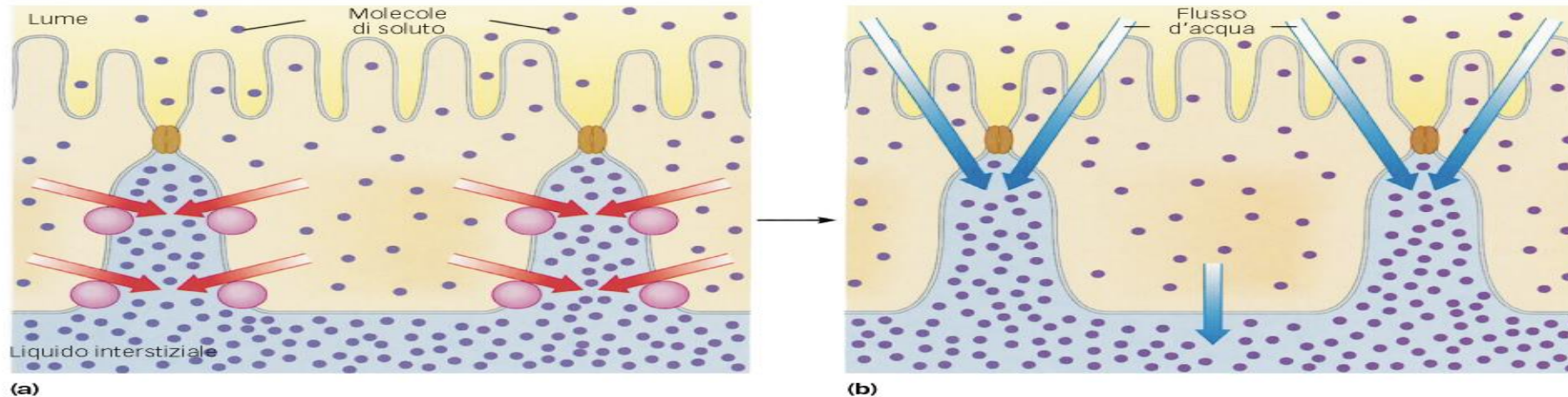

Il trasporto attivo sulla membrana basolaterale crea una **pressione osmotica** attraverso l'epitelio che genera un flusso di acqua dal lume al liquido interstiziale (**assorbimento**).

Può accadere il contrario se l'H₂O è **secreta**.

Adesioni cellula-cellula



UNIVERSITÀ
DEGLI STUDI
DI TORINO

- durante lo sviluppo e la crescita le membrane di cellule adiacenti formano connessioni (giunzioni) che possono rimanere permanenti
- si distinguono tre tipi di giunzioni: *serrate*, *comunicanti* e *aderenti (desmosomi)*

Giunzioni serrate (tight junctions)

- sono presenti nei tessuti epiteliali degli organi cavi che assorbono e rilasciano ioni e molecole (rene e tratto gastrointestinale)
- formano una barriera impermeabile alle sostanze polari tra il lato luminale e il lato sierosale
- **trasporto transepiteliale** (attraverso le cellule)
- **trasporto paracellulare** (tra le cellule)

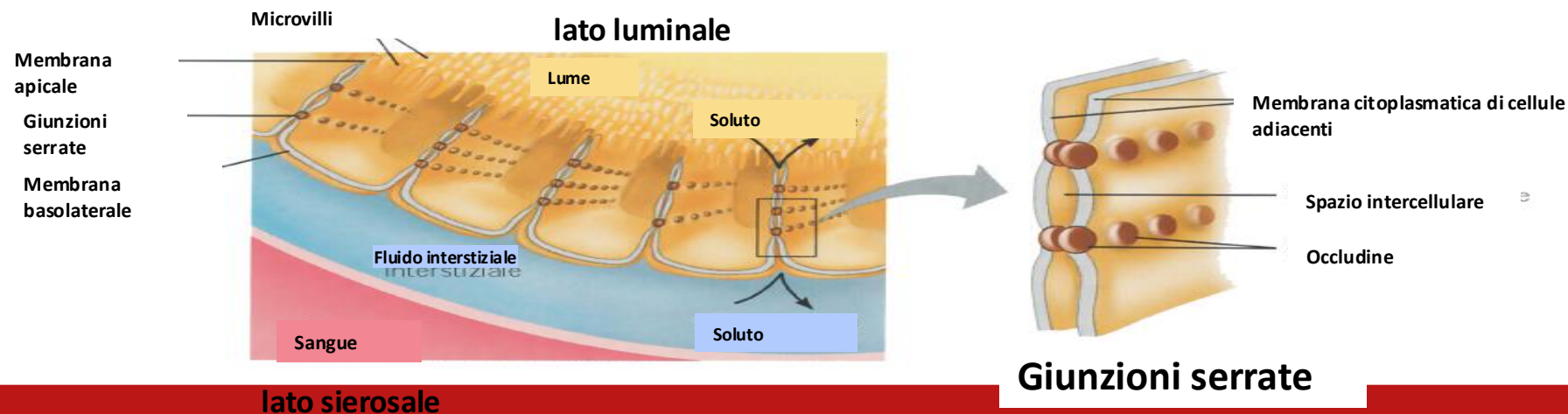



Domande chiave Trasporti

- Cosa s'intende per trasportatori? Qual è la differenza con la diffusione semplice?
- Che differenza c'è tra trasporti attivi e passivi?
- Caratteristiche dei cotrasportatori. Esempi
- Ruolo dell'accoppiamento dei flussi. Esempi chiave



Department of
Life Sciences
and Systems Biology

UNIVERSITÀ
DI TORINO



Department of
Life Sciences
and Systems Biology

UNIVERSITÀ
DI TORINO





Department of
Life Sciences
and Systems Biology

UNIVERSITÀ
DI TORINO



Department of
Life Sciences
and Systems Biology

UNIVERSITÀ
DI TORINO

Thank you